

# Butterfly iQ+ / iQ+ Bladder Personal Ultrasound System

---

User Manual



950-20053-00  
Revision: B  
2024-12-04

## Notice

Butterfly Network, Inc. (BNI), shall not be liable for errors contained herein or for incremental or consequential damages in connection with the furnishing, performance, or use of this material.

### Proprietary Information

This document contains proprietary information, which is protected by copyright.

### Limited Warranty

The “Limited Warranty” shipped with BNI products serves as the sole and exclusive warranty provided by BNI with respect to the products contained herein.

### Copyright

Copyright © 2024 Butterfly Network, Inc. All Rights Reserved.

### Trademark Acknowledgements

Product names mentioned in this manual may be trademarks of their respective owners.

iPad®, iPad Air®, iPad Pro®, iPhone®, iPod®, and Lightning® are trademarks of Apple Inc., registered in the U.S. and other countries and regions.

Android is a trademark of Google LLC.

### Legal Notice

Use of the Made for iPhone | iPad | iPod badge means that an accessory has been designed to connect specifically to iPhone, iPad, or iPod and has been certified by the developer to meet Apple performance standards. Apple is not responsible for the operation of this device or its compliance with safety and regulatory standards. Please note that the use of this accessory with an Apple product may affect wireless performance.

### Manufacturer

Butterfly Network, Inc. 1600 District Ave, Burlington, MA 01803 USA

**Telephone:** +1 (855) 296-6188

**General inquiries:** [info@butterflynetwork.com](mailto:info@butterflynetwork.com)

**Support and service:** [support@butterflynetwork.com](mailto:support@butterflynetwork.com)

**Website:** [www.butterflynetwork.com](http://www.butterflynetwork.com)



### Authorized Representatives / Sponsors



Emergo Europe  
Westervoortsedijk 60  
6827 AT Arnhem  
The Netherlands

CH REP

MedEnvoy Switzerland  
Gotthardstrasse 28  
6302 Zug  
Switzerland

Emergo Australia  
Level 20, Tower II  
Darling Park  
201 Sussex Street  
Sydney, NSW 2000  
Australia

## Importers



Butterfly Network Netherlands B.V.  
Edisonweg 17  
4207 HE Gorinchem  
The Netherlands



MedEnvoy Switzerland  
Gotthardstrasse 28  
6302 Zug  
Switzerland

## US Patents

Listing of applicable U.S. Patents in compliance with 35 U.S.C. §287: [www.butterflynetwork.com/patents](http://www.butterflynetwork.com/patents)

## Disclaimer

The information contained in this document is subject to change without notice. Some feature sets may not be available to certain user groups based on platform and local regulatory restrictions. Names and data used in examples are fictitious unless otherwise noted.

To obtain a printed copy of this manual at no additional cost, contact support at [support@butterflynetwork.com](mailto:support@butterflynetwork.com), and one will be provided within 7 days of the request.

# Table of Contents

<b>1. Introduction</b>	<b>7</b>
1.1. Overview	7
1.2. Intended Uses	7
1.3. Indications for Use	7
1.4. Training	8
1.4.1. Caption AI™	9
<b>2. Safety Information</b>	<b>10</b>
2.1. Safety Conventions	10
2.2. Ultrasound Benefits and Risks	10
2.2.1. Ultrasound Benefits	10
2.2.2. Ultrasound Risks	10
2.3. Butterfly iQ+ Safety	11
2.4. Basic Safety/Usage Environment	11
2.5. Electrical Safety	14
2.6. Defibrillation Safety	15
2.7. Equipment Protection	15
2.8. Biological Safety	16
2.9. Operator Safety	17
<b>3. System Overview</b>	<b>18</b>
3.1. Overview	18
3.1.1. Modes	19
3.1.2. Measurements	19
3.1.3. Probe Types	19
3.1.4. Patient Data Protection	19
3.1.5. Internet Connectivity	20
3.2. System Components	20
3.2.1. Butterfly iQ App	21
3.2.2. Probe	22
3.2.3. Probe Battery Charger	24
3.3. Overview of User Interface	25
3.4. Presets	25
3.5. Preset Families	25
<b>4. Setting Up the System</b>	<b>26</b>
4.1. Downloading and Installing the App	26
4.2. Updating Firmware	26
4.3. Managing App Updates	27
4.4. Charging the Probe	27
4.4.1. Checking Probe Battery Level	29
<b>5. Using the System</b>	<b>30</b>
5.1. Performing a Study	30
5.2. Uploading to Butterfly Cloud	31
5.3. Using the Probe Button Functionality	31
5.3.1. Using the Probe Button Push capture functionality:	31
5.3.2. Using the Probe Button Push unfreeze functionality:	31
<b>6. Using Modes</b>	<b>33</b>
6.1. Using B-Mode	33
6.2. Using Color Doppler Mode or Power Doppler Mode	33
6.3. Using M-Mode	33
6.4. Using Spectral Pulsed-Wave Doppler Mode	34
6.5. Using Biplane Imaging™	36
6.6. Using Fetal Heart Sounds	37
<b>7. Annotations</b>	<b>39</b>
7.1. Adding Annotations	39
7.2. Using Protocols	40

<b>8. Manual Calculations Packages</b>	<b>42</b>
8.1. Obstetric Calculations	42
8.2. Manually Calculate Volume	43
8.3. Gastric Volume Calculation	44
8.4. Carotid Diameter Reduction Calculation	45
8.5. Manually calculate angles	46
8.6. Calculation Package References	47
<b>9. Using the Needle Viz™ (in-plane) Tool</b>	<b>48</b>
<b>10. AI-Assisted Tools</b>	<b>50</b>
10.1. Butterfly Auto B-line Counter	50
10.2. Automatically Estimating Ejection Fractions	58
10.3. Automatically Estimating Bladder Volume	61
10.4. Butterfly iQ Educational View Guidance	65
<b>11. Using Butterfly Cloud</b>	<b>67</b>
11.1. Overview	67
11.2. Accessing Butterfly Cloud	67
11.3. Viewing and Managing Studies	67
<b>12. Using Butterfly TeleGuidance</b>	<b>69</b>
12.1. Overview	69
<b>13. Using Butterfly iQ+ Care</b>	<b>70</b>
<b>14. Using Butterfly iQ+ Bladder System</b>	<b>72</b>
14.1. Overview	72
14.2. Indications for Use	72
14.3. Contraindications	72
14.4. Acquiring a Bladder Volume	72
14.4.1. Acquiring a Bladder Volume with Auto Bladder Volume Tool	73
14.4.2. Acquiring a Bladder Volume with the Manual Volume Calculation Package	74
14.5. Available Settings	75
<b>15. Connecting the Power Source using a Mobile Device Charging Kit</b>	<b>76</b>
15.1. Connecting the Mobile Device Charging Kit to the Butterfly iQ+/iQ+ Bladder	76
15.2. Mobile Device Charging Kit Components	77
<b>16. Maintenance</b>	<b>78</b>
16.1. Maintaining the Probe	78
16.2. Cleaning and Disinfecting the Probe at the Point-of-Use	79
16.2.1. Cleaning the Probe	80
16.2.2. Disinfecting the Probe	81
16.3. Updating the Probe and App Software	84
16.4. Performing the Probe Diagnostic Test	84
16.5. Replacing the Butterfly iQ+ Cable	85
16.6. Scheduled maintenance	88
16.7. Expected service life for Butterfly iQ+	88
<b>17. Troubleshooting</b>	<b>89</b>
17.1. Troubleshooting	89
17.2. Troubleshooting overheating issues with the probe	90
17.3. Troubleshooting Charging Issues	91
<b>18. Getting Support</b>	<b>93</b>
18.1. Contacting Butterfly Support	93
18.2. Contacting Support through the Butterfly iQ App	93
<b>19. Specifications</b>	<b>94</b>
19.1. Mobile Device Requirements	94
19.2. System Specifications	94
19.3. Probe Battery Charger	95
19.4. Environmental Operating Conditions	95
19.5. Electromagnetic Conformance (EMC)	96
19.5.1. Separation Distances	97
19.6. Acoustic Output	98
19.6.1. Acoustic Output Limits	100

---

19.6.2. Acoustic Output Tables .....	100
19.7. Essential Performance .....	110
19.8. Measurement Accuracy .....	110
19.9. Waste Electrical and Electronic Equipment .....	110
19.10. Recycling and Disposal .....	110
<b>20. Symbols .....</b>	<b>112</b>
20.1. Symbols .....	112

# 1. Introduction

This chapter provides an introduction to the Butterfly iQ+ Personal Ultrasound System.

## 1.1. Overview

Butterfly iQ+ personal ultrasound is designed to be easy to use, portable, and battery powered. Its commercial off-the-shelf mobile platform (mobile device) provides a simple interface for the user.



### NOTE

The Butterfly iQ+ Bladder probe is a configuration of the Butterfly iQ+ hardware platform, and thus shares its mechanical and electrical specifications.

This manual is intended to provide information to guide trained operators in the safe and effective operation and proper maintenance of Butterfly iQ+ personal ultrasound, and applicable accessories. It is important that you read and understand all instructions in this manual before operating the system, and pay careful attention to the warnings and cautions throughout the manual.



### NOTES

- Depending on your platform, hardware, country and membership type, certain presets, modes and features may not be available.
- The Butterfly iQ+ and its accessories may be used multiple times on multiple patients.

## 1.2. Intended Uses



### CAUTION!

Federal law restricts the sale of this device by or on the order of a physician.

Butterfly iQ+ is a general-purpose diagnostic ultrasound imaging system for use by a trained healthcare professional enabling diagnostic imaging, measurement of anatomical structures and fluid, and other applicable tools.

## 1.3. Indications for Use



### NOTE

All presets and features may not be available. Please visit [support.butterflynetwork.com](https://support.butterflynetwork.com) for information specific to your device and country.

Butterfly iQ+ is indicated for use by trained healthcare professionals in environments where healthcare is provided to enable diagnostic ultrasound imaging and measurement of anatomical structures and fluids of adult and pediatric patients for the following clinical applications:

- Peripheral Vessel (including carotid, deep vein thrombosis and arterial studies)
- Procedural Guidance
- Small Organs (including thyroid, scrotum and breast)
- Cardiac
- Abdominal
- Lung
- Urology
- Fetal/Obstetric
- Gynecological
- Musculoskeletal (conventional)
- Musculoskeletal (superficial)
- Ophthalmic

Mode	Butterfly iQ+
B-Mode	✓
B-Mode + M-Mode	✓
B-Mode + Color Doppler	✓
B-Mode + Power Doppler	✓
Spectral Pulsed Wave Doppler <sup>a</sup>	✓
Fetal Heart Sounds <sup>a</sup>	✓
B-Mode + Biplane	✓
B-Mode + Needle Viz Tool	✓
B-Mode + Biplane + Needle Viz Tool	✓

<sup>a</sup>Not available in all countries.



**WARNING!**

Butterfly iQ+ should not be used for indications other than the ones approved by the applicable governing agency.

## 1.4. Training

In order to safely and effectively operate Butterfly iQ+, the user shall meet the following:

- Training as required by local, state, provincial, and national regulations
- Additional training as required by the authorizing physician
- A thorough knowledge and understanding of the material presented in this manual



### 1.4.1. Caption AI™



#### **WARNING**

If you are using the Caption AI™ accessory on the Butterfly iQ+ ultrasound system, you must carefully read and understand the Caption AI™ Operator's Manual.



#### **NOTE**

Caption AI™ is only available in the USA and only on the Butterfly iQ+.



#### **NOTES**

- Depending on your platform, hardware, country and membership type, certain presets, modes and features may not be available.
- The Butterfly iQ+ and its accessories may be used multiple times on multiple patients.

Please visit the [Caption Health website](#) for Caption AI™ instructions for Use and other important information.

## 2. Safety Information

This chapter provides important safety information for using Butterfly iQ+ and includes a list of warning and caution messages. This user manual is accessible from the Butterfly iQ App and through the website [support.butterflynetwork.com](http://support.butterflynetwork.com).

### 2.1. Safety Conventions

**WARNING!**

Conditions, hazards, or unsafe practices that may result in serious personal injury or death.

**CAUTION!**

Conditions, hazards, or unsafe practices that may result in minor personal injury, damage to the device, or loss of data.

This user manual is intended to assist in the safe and effective operation of Butterfly iQ+. It is important that all users review and understand all instructions in this user manual before operating the device, paying careful attention to the warnings and cautions throughout the manual. The following conventions are used throughout this manual to highlight safety concerns:

### 2.2. Ultrasound Benefits and Risks

Ultrasound is widely used because it provides many clinical benefits to the patient and has an excellent safety record. Ultrasound imaging has been used for over twenty years and there have been no known long-term negative side effects associated with this technology.

#### 2.2.1. Ultrasound Benefits

- Multiple diagnostic uses
- Immediate results
- Cost-effectiveness
- Portability
- Safety record

#### 2.2.2. Ultrasound Risks

Ultrasonic waves can heat the tissues slightly. It is normal that the probe may feel warm to the touch while charging. If you remove the probe from the charging pad before or immediately after charging is complete, it is recommended that you allow the probe to cool down before use. Since the system limits patient contact temperature and will not scan at or above 43°C (109°F), allowing the probe to cool down before use will optimize scan time performance.

Any serious incident that occurs in relation to the device should be reported to the manufacturer at <http://support.butterflynetwork.com> (and to the competent authority of the EU Member State in which the incident occurred, if applicable).

## 2.3. Butterfly iQ+ Safety



### WARNINGS!

- The Butterfly iQ+ is intended for use by competent users capable of interpreting image quality, diagnosis, and clinical utility of the system.
- Movement of the patient during scanning may impact results. User should exercise clinical judgement in the interpretation of results.
- Do not use Butterfly iQ+ until the materials present in this manual have been reviewed and fully understood. Do not operate Butterfly iQ+ for purposes other than intended in this manual.
- Do not operate Butterfly iQ+ improperly. Failure to do so may result in serious personal injury or death.

## 2.4. Basic Safety/Usage Environment



### WARNING!

Butterfly iQ+ is classified as MR Unsafe and may pose unacceptable risks to the patient, medical staff, or other persons within the MR environment.





## WARNINGS!

- Use only cables, probes, chargers, and accessories specified for use with Butterfly iQ+. Substitution of non-approved accessories may cause the system to perform improperly or may cause injury to the patient or operator.
- If the probe seems unusually hot, produces an odor or smoke, or leaks, stop use immediately. Unplug the probe from the mobile device or disconnect it from the charger (if applicable). Submit a ticket for support at: [support.butterflynetwork.com](https://support.butterflynetwork.com).
- Any serious incident that occurs in relation to the device should be reported to the manufacturer at <http://support.butterflynetwork.com> (and to the competent authority of the EU Member State in which the incident occurred, if applicable): <https://www.ema.europa.eu/en/partners-networks/eu-partners/eu-member-states/national-competent-authorities-human>.
- Do not use Butterfly iQ+ in the presence of flammable gases or anesthetics. Doing so can result in a possible fire or explosion.
- Butterfly iQ+ has not been evaluated or approved for use in hazardous locations as defined in the National Electric Code standard. In compliance with IEC classification, the Butterfly iQ+ is not to be used in the presence of flammable substances/air mixtures.
- Do not use the Butterfly iQ Application on a mobile device that does not meet minimum requirements. Using the Butterfly iQ Application on a mobile device that does not meet the minimum requirements may affect performance and image quality, possibly resulting in misdiagnosis.
- Spilling fluids into the system may damage it or present a fire or shock hazard. Do not allow fluids to enter the device or the charging system.
- Store only within the range of environmental conditions specified in the technical specifications.
- Dangerous high voltages and currents are present. There are no user-serviceable parts. Do not open, remove covers, or attempt repair.
- Portable and mobile radio-frequency (RF) communications equipment can affect Medical Electrical Equipment.
- Internet access is required to view the user manual and Butterfly support portal. If you intend to use Butterfly iQ+ without an internet connection download the user manual locally by visiting [support.butterflynetwork.com](https://support.butterflynetwork.com).
- Use of damaged equipment or accessories may cause the device to perform improperly and/or result in injury to the patient or operator. Refer servicing to qualified service personnel.
- No modification is allowed. Do not modify cables, probes, chargers, or accessories specified for use with Butterfly iQ+. Modification to equipment may cause the system to perform improperly or may cause injury to the patient or operator.
- When the probe is used in a home environment, the probe should be stored away to prevent any harm from or to pets, pests, or children.
- When the probe is used in a home environment, it is imperative that the cord be properly wrapped around the probe when not in use to avoid the potential for accidental strangulation.



## CAUTIONS!

- Cardiac rhythm disturbances during cardiac studies using gas ultrasound contrast agents have been observed in the diagnostic range of Mechanical Index (MI) values. See the specific package insert for the contrast agent being used for further details.
- Butterfly Cloud enables remote viewing of ultrasound images on a variety of platforms and in uncontrolled environments (e.g., ambient lighting). Clinician discretion on the appropriate use of images must be applied.
- Only trained operators should use the instrument for needle placement.
- Special precautions should be considered when using the transducer on children or other patients who may have pre-existing conditions or sensitivity to temperature.



## NOTES

The Butterfly iQ+ has been designed to ensure that acoustic limits are not exceeded in any imaging mode. The Butterfly iQ+ has been designed and certified to comply with:

- IEC 60601-1:2005+AMD1:2012+AMD2:2020 CSV Medical electrical equipment Part 1: General requirements for basic safety and essential performance.
- IEC 60601-2-37:2007 Medical electrical equipment - Part 2-37: Particular requirements for the basic safety and essential performance of ultrasonic medical diagnostic and monitoring equipment.

## 2.5. Electrical Safety



### WARNINGS!

- Before use, carefully inspect the probe. Always inspect the probe before and after cleaning, disinfection, or use. Check the lens face, cable, housing, seams, and connector for signs of damage such as cracks, chips, abrasions, or leaks. To avoid the risk of electrical hazards, do not use the probe if there is any sign of damage. For Butterfly iQ+ probes, check that the cable is fully installed.
- Dropping the probe may cause damage. Always inspect the probe before and after cleaning, disinfection, or use. Check the lens face, cable, housing, seams, and connector for signs of damage such as cracks, chips, abrasions, or leaks. To avoid the risk of electrical hazards, do not use the probe if there is any sign of damage.
- Comply with IEC 60601-1 when using additional equipment along with the ultrasound device.
- Use of accessories, probes, and cables other than those specified or provided by the manufacturer of this equipment could result in increased electromagnetic emissions or decreased electromagnetic immunity of this equipment and result in improper operation.
- Use of this equipment adjacent to or stacked with other equipment should be avoided because it could result in improper operation. If such use is necessary, this equipment and the other equipment should be observed to verify that they are operating normally.
- Electrical shock to the patient or operator may result if voltages exceeding IEC 60601-1 for patient-applied parts are exceeded.
- The probe is designed to remain sealed. Do not attempt to open the probe or tamper with the device internals, including the battery. Doing so may cause injury to the patient or operator.
- The cable on the Butterfly iQ+ is designed to be removed by the user, but the user should check that the cable is fully installed to ensure the probe is protected from the external environment.
- Do not immerse the Butterfly iQ/ iQ+ probe beyond specified levels. Immersion beyond specified levels may result in electrical shock.



### WARNINGS!

- Portable RF communications equipment (including peripherals such as antenna cables and external antennas) should be used no closer than 30 cm (12 inches) to any part of the Butterfly iQ+, including cables specified by the manufacturer. Otherwise, degradation of the performance of this equipment could result.



**CAUTIONS!**

- Notifications and alerts from other third-party applications running on the mobile device may interfere with the study.

Class Designation	Butterfly iQ+	Notes
CISPR 11 Group 1 Class A	✓	Devices in this class are suitable for use in industrial areas and hospitals. If this equipment is used in a residential environment (for which CISPR 11 Class B is normally required), this equipment might not offer adequate protection to radio frequency communication services. The user might need to take mitigation measures, such as relocating or re-orientating the equipment.
CISPR 11 Group 1 Class B	✓	Devices in this class are suitable for use in a residential environment. If the device does not meet this designation, the equipment might not offer adequate protection to radio frequency communication services and the user might need to take mitigation measures, such as relocation or re-orientating the equipment.

- Do not use probe with a cable that has visible damage. Damage includes, but is not limited to, cable insulation cracks, exposed wires, fraying, or any other visible wear.
- Use of the device with visible cable damage may result in injury to the user and/or patient.

## 2.6. Defibrillation Safety



**WARNINGS!**

- Before applying a high-voltage defibrillation pulse to the patient, remove all patient-contact devices that are not indicated as defibrillation-proof.
- Probe covers do not provide protection from defibrillation.

## 2.7. Equipment Protection



**CAUTIONS!**

- Do not overly bend or twist the probe cable. Always inspect the probe before and after cleaning, disinfection, or use. Check the lens face, cable, housing, seams, and connector for signs of damage such as cracks, chips, abrasions, or leaks. To avoid the risk of electrical hazards, do not use the probe if there is any sign of damage. Do not immerse the probe in water or liquids beyond specified levels.
- To avoid the possibility of internal condensation and possible damage, do not store the device outside of the specified environmental operating conditions.
- Improper maintenance may cause Butterfly iQ+ not to function. Maintain the equipment only as described in the maintenance section.
- Do not sterilize or autoclave the Butterfly iQ+ or its accessories.

## 2.8. Biological Safety



### WARNINGS!

- Always use the ALARA (As Low As Reasonably Achievable) principle when performing an ultrasound study. Additional information on the ALARA principle can be found in the section on "Ultrasound Safety" under [Acoustic Output \[98\]](#).
- If Butterfly iQ+ is contaminated due to exposure to Creutzfeldt-Jakob disease, there is no adequate disinfecting procedure.
- Use the correct clinical application presets for the associated body part being examined. Some applications require lower acoustic output limits.
- There are no latex parts in the probe. However, some probe sheaths may contain natural latex, which can cause allergic reactions in some people.
- If performing procedures that require transducer covers, follow your institution's protocol and/or the instructions provided with the covers.
- This product can expose you to chemicals including Carbon black, which is known to the State of California to cause cancer. For more information go to [www.P65Warnings.ca.gov](http://www.P65Warnings.ca.gov).
- FDA has established lower acoustic output limits for ophthalmic use. To avoid injury to the patient, use only the Ophthalmic preset when performing ocular examinations.



### CAUTION!

Avoid contact with mucous membranes (e.g. eye, nose, mouth) and non-intact areas of the skin that have been opened by cuts, abrasions, dermatitis, chapped skin, etc unless probe has been disinfected and protected by sterile, legally marketed probe sheath according to your institution's protocol and/or instructions provided with the covers.



## 2.9. Operator Safety



### WARNINGS!

- Use of damaged equipment or accessories may cause the device to perform improperly and/or result in injury to the patient or operator.
- Do not use, connect, or operate the Butterfly iQ+ with non-approved or non-specified equipment or accessories. Doing so may result in injury to the patient or operator.
- Do not use the Butterfly iQ Application on a mobile device that does not meet minimum requirements. Using the Butterfly iQ Application on a mobile device that does not meet the minimum requirements may affect performance and image quality, possibly resulting in misdiagnosis.



### CAUTIONS!

- To minimize the risk of Carpal Tunnel Syndrome (CTS) and related musculoskeletal issues, maintain suitable posture, allow for frequent breaks, and avoid gripping or holding the probe with excessive force.
- Follow your institution's personal protective equipment (PPE) and infection control procedures (e.g. eye, respiratory, and hand protection) when operating, cleaning, or disinfecting the device.

## 3. System Overview

This chapter provides an overview of Butterfly iQ+. It includes information about its features, the components that are included in the system, requirements necessary to download, install, and use the Butterfly iQ App, and an overview of the user interface.



### NOTES

- Depending on your platform, hardware, country and membership type, certain presets, modes and features may not be available.
- The Butterfly iQ+ and its accessories may be used multiple times on multiple patients.

**Figure 1. System overview**

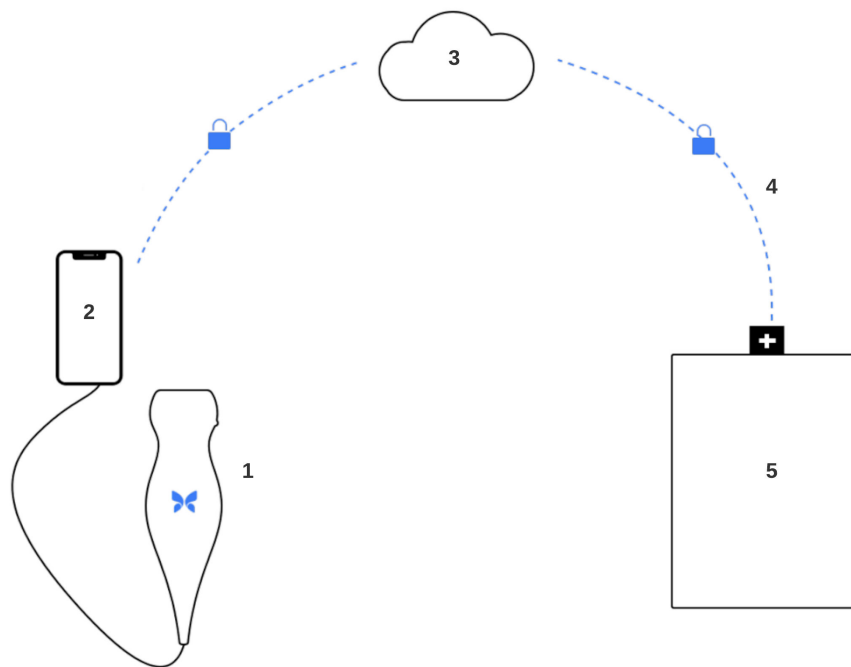

1. Butterfly iQ+ Probe.
2. Butterfly iQ application.
3. Butterfly Cloud.
4. Butterfly Cloud hospital link.
5. HL7, DICOM, PACS.

### 3.1. Overview

Butterfly iQ+ is a hand-held general purpose diagnostic ultrasound imaging device. The system consists of three components:

- Compatible Apple® or Android personal electronic devices including phones and tablets (the mobile device)
- The Butterfly iQ Application (App), downloaded and installed on the compatible mobile device
- The Butterfly iQ+ Probe that connects to the mobile device to generate and receive ultrasound signals



**NOTE**

The mobile device is not included with the Butterfly iQ+ Ultrasound System; you must purchase it separately.

**3.1.1. Modes**

Butterfly iQ+ provides the following modes:

Mode	Butterfly iQ+
B-Mode	✓
B-Mode + M-Mode	✓
B-Mode + Color Doppler	✓
B-Mode + Power Doppler	✓
Spectral Pulsed Wave Doppler <sup>a</sup>	✓
Fetal Heart Sounds <sup>a</sup>	✓
B-Mode + Biplane	✓
B-Mode + Needle Viz Tool	✓
B-Mode + Biplane + Needle Viz Tool	✓

<sup>a</sup>Not available in all countries.

**3.1.2. Measurements**

Butterfly iQ+ lets you perform clinical measurements in each available mode. Measurements available include, but are not limited to distance, time, area and heart rate.

**3.1.3. Probe Types**

Butterfly iQ+ provides a single probe that is capable of performing all indicated clinical applications.

**3.1.4. Patient Data Protection**



**CAUTION!**

It is required that you protect patient data by encrypting your mobile device with a password or passcode. You cannot use the Butterfly iQ App if your mobile device does not have a passcode enabled and configured. Consult with your IT/Security department to ensure that security and patient data protection is in accordance with the policy of your institution.

Butterfly recommends setting an auto-lock period within the mobile device’s settings to prevent unauthorized access. For more information, consult your mobile device’s instructions for Auto-Lock settings.

Please contact your organization’s IT or Security teams if you suspect you were the target or victim of a phishing attempt or other cybersecurity attacks or if you have any concerns regarding the safety and integrity of your device. Security issues within the Butterfly product can be reported to our support team via email. See [Getting Support \[93\]](#) for more information. Security issues identified within the Butterfly probe and application, as well as their remediation guidelines, will be communicated through email to users that have an active account, and will also be published on the Butterfly support portal at [support.butterflynetwork.com](http://support.butterflynetwork.com).

### 3.1.5. Internet Connectivity

An Internet connection is required to download, install, or update the Butterfly iQ App from the Apple App Store or Google Play Store. An Internet connection is also required to log in and to archive studies to Butterfly Cloud. Otherwise, no Internet connection or wireless connectivity is required to use the mobile device.

In order to ensure the app has the latest updates and safety information, the app requires a connection to the internet once every 30 days. For additional information about internet connectivity requirements and settings please visit [support.butterflynetwork.com](http://support.butterflynetwork.com).

Transport Layer Security (TLS) encryption is used to secure data in transit from the mobile application.

## 3.2. System Components



### WARNING!

Upon receiving your Butterfly iQ+, carefully inspect the probe. Always inspect the probe before and after cleaning, disinfection, or use. Check the lens face, cable, housing, seams, and connector for signs of damage such as cracks, chips, abrasions, or leaks. To avoid the risk of electrical hazards, do not use the probe if there is any sign of damage.

The probe and probe charger are included with your Butterfly iQ+. Before getting started, identify each component and ensure that your package is complete.

The following table shows a summary of the system components found inside the package:

**Table 1. System Component Summary – Inside the Package**

	Butterfly iQ+
	Probe (1)
Component (Quantity)	Cable (1)
	Charging System (1)



### NOTE

The mobile device is not included with the Butterfly iQ+ Ultrasound System; you must purchase it separately.

### 3.2.1. Butterfly iQ App

The primary function of the Butterfly iQ App is general-purpose diagnostic imaging, for use by qualified and trained healthcare professionals to enable the visualization and measurement of anatomical structures within the human body.

The app is a free download from the Apple App Store or Google Play Store. The app and Butterfly account are required to use the Butterfly iQ+ personal ultrasound.



#### NOTE

- If your mobile device does not meet the requirements necessary to download, install, or run the Butterfly iQ App, the mobile device displays a notification. For the most up to date list of compatible devices please visit [support.butterflynetwork.com](https://support.butterflynetwork.com).
- Information Security: Follow all security and cybersecurity policies of your institution. If you do not know what these policies are, contact your information technology (IT) department. To use the Butterfly iQ App, it is required that you set a password, passcode, or other security settings to lock the screen of your mobile device. If you have not done this and do not know how, refer to the security instructions for your mobile device.



#### CAUTION!

The Butterfly iQ mobile application should only be run on devices that are not jailbroken or rooted to ensure security and data integrity. The Butterfly iQ mobile application implements software checks to ensure the device is not jailbroken or rooted.



#### NOTE

- A machine readable (SPDX) version of the Software Bill Of Materials (SBOM) can be obtained by contacting our support team via email. See [Getting Support \[93\]](#) for more information.
- Hardware details of the probe such as its identifier, its working conditions (e.g. temperature, etc.) are logged. All activities performed by a user in the Butterfly application are logged by User ID and date/time that the activity was performed. Activities logged include logon, failed login attempts, images or studies created/viewed/modified/deleted.
- Consult your device's operational manual for factory reset of the device, or contact your organization for instructions on how to properly reset your MDM managed mobile device.

### 3.2.2. Probe



#### **WARNING!**

Do not connect third-party probes to the Butterfly iQ+ mobile device and do not attempt to use the Butterfly iQ+ probe with other ultrasound systems.

The Butterfly iQ+ probe is only for use with the Butterfly iQ App. Do not attempt to connect the probe to other ultrasound systems. [The following figure \[22\]](#) shows the parts of the probe and describes its parts.

Butterfly iQ+

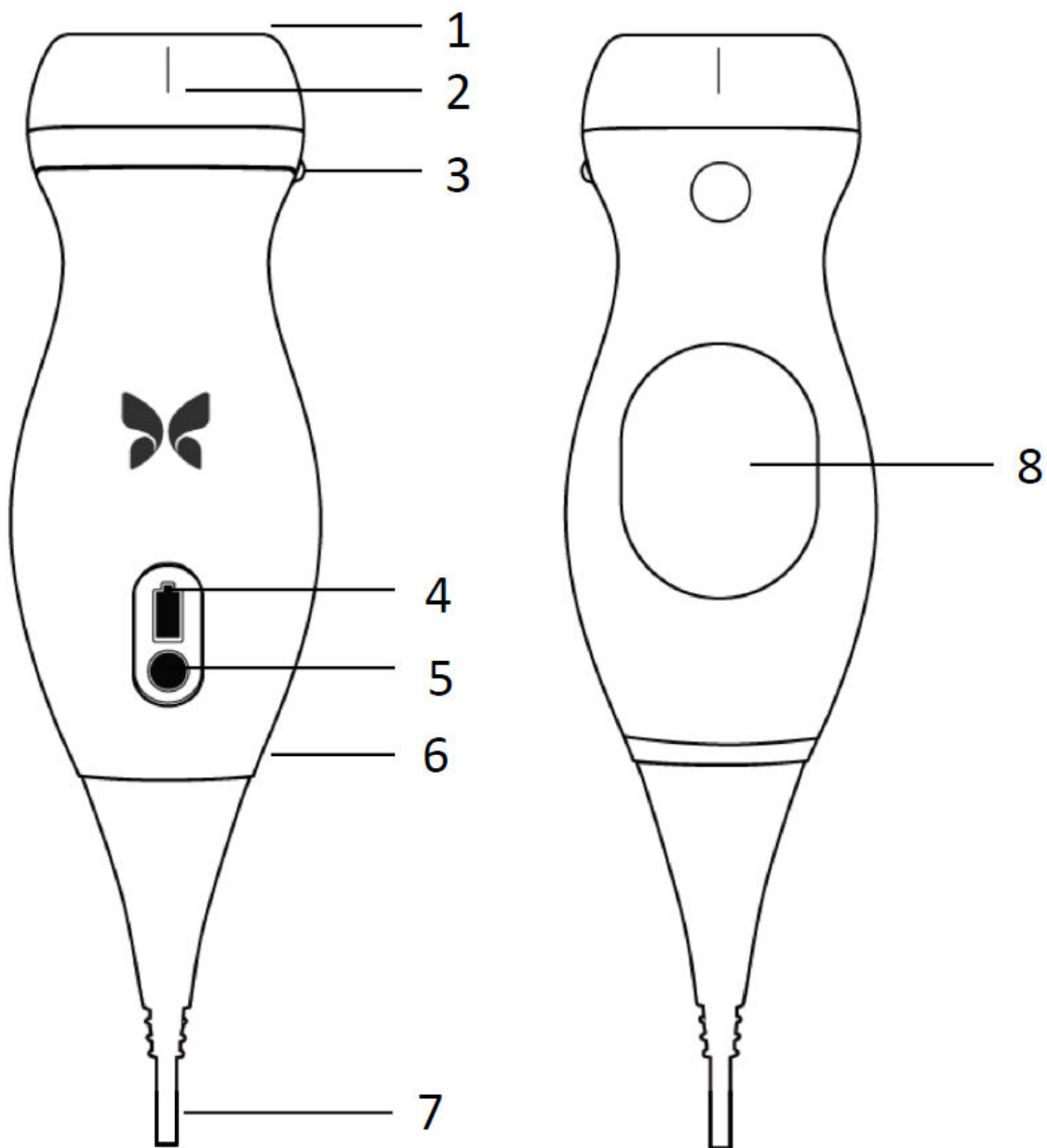

Probe components.

**Table 2. Probe components**

Butterfly iQ+	
1.	Lens
2.	Midline Mark
3.	Orientation Mark
4.	Battery Indicator Lights
5.	Battery Indicator Button
6.	Probe/Cable Boundary
7.	Mobile Device Cable
8.	Charging Source

### 3.2.3. Probe Battery Charger

Only use the charger supplied with the probe.

The following figure [24] shows the battery charging accessories.

Butterfly iQ+ charger

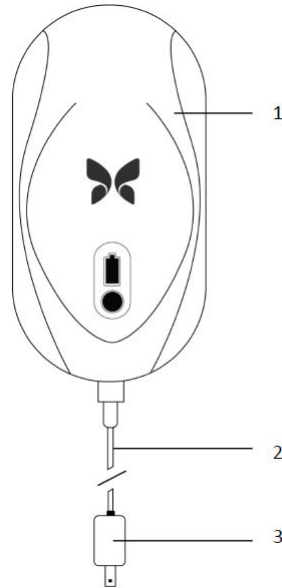

Charging System Components.

**Table 3. Charging System Components**

Butterfly iQ+	
1.	Charging Pad
2.	Charging Cable
3.	Wall Adaptor



#### NOTES

- The latest Butterfly iQ+ charger has a matte black finish and curved probe cradle. If you have a previous model please see [Probe Battery Charger \[95\]](#) for additional information on charging your probe.
- The electronic interface/connection is not meant to control the operation of another medical device or accessory.



### 3.3. Overview of User Interface

This section provides information about the imaging display presented in the Butterfly iQ App user interface.

The app user interface will always show information about the Mechanical Index (MI) and the Thermal Index (TI) at the top of the screen.

Depending on your Butterfly membership status and mobile app version, the toolbar at the bottom of the screen may vary.

The toolbar at the bottom of the screen can be used for preset selection, image freeze, image capture and mode/tool selection.

### 3.4. Presets

Presets are a predefined set of imaging parameter values. When selected, the Butterfly iQ App automatically operates in accordance with the corresponding set of imaging parameter values. Presets available correspond to the clinical applications details in [Indications for Use \[7\]](#). Preset availability may also vary depending on probe, Butterfly membership status and geographic location.

The following table shows the available presets for the Butterfly iQ+.

**Table 4. Presets availability**

Probe	Presets
Butterfly iQ+	Abdomen, Abdomen Deep, Aorta & Gallbladder, Bladder, Cardiac, Cardiac Coherence, Cardiac Deep, FAST, Lung, Lung Tissue, MSK-Soft Tissue, Musculoskeletal, Nerve, OB 1/GYN, OB 2/3, Ophthalmic, Pediatric Abdomen, Pediatric Cardiac, Pediatric Lung, Small Organ, Vascular: Access, Vascular: Carotid, Vascular: Deep Vein, Vascular: Superficial

### 3.5. Preset Families

Certain presets which are aimed for the same or similar clinical applications are grouped together under one global preset, this grouping is done to facilitate easier access and evaluation of the different presets for the patient being imaged. To access the other presets within the same family tap on the screen. Additional controls will appear on the bottom left side of the exam screen. If the preset has other presets in the same family, tapping on the presets filter button  will cycle you between the different presets within the family.

## 4. Setting Up the System

This chapter provides information and instructions for downloading and installing the Butterfly iQ App, registering the probe, setting up the Butterfly iQ App, and charging the probe for use.

### 4.1. Downloading and Installing the App

You can download and install the Butterfly iQ App by visiting the Apple App Store or Google Play Store on your mobile device. Once in the applicable app store, search for "Butterfly iQ".

Before downloading and installing the app, make sure your mobile device meets or exceeds the minimum performance specifications. Additional information on the most up to date device requirements can be found at [support.butterflynetwork.com](http://support.butterflynetwork.com).



#### NOTE

If you cannot install the app, it may indicate that your mobile device does not meet the minimum performance specifications. For details on the requirements, see [support.butterflynetwork.com](http://support.butterflynetwork.com).

### 4.2. Updating Firmware

The firmware on your mobile device must be up-to-date to perform imaging. Certain app updates may require a firmware upgrade of your Butterfly iQ+. Firmware updates will be triggered on the first connection of the Butterfly iQ+ probe following an app update.

We recommend enabling notifications from Butterfly on your mobile device so you can proactively update your probe's firmware. We will send a push notification when a firmware update is needed, so you can complete this step before you need to use the probe.

#### To receive firmware update notifications

##### On an iOS device

1. Ensure you are using the latest version of the Butterfly iQ App.
2. In the Butterfly iQ App, click your avatar at the bottom right corner of the screen to access your Profile and navigate to Notifications.
3. Toggle "Push" to enable push notifications.
4. Navigate to your mobile device's Settings.
5. Select "Butterfly iQ" and toggle "Allow Notifications" on.

##### On an Android device

1. Ensure you are using the latest version of the Butterfly iQ App.
2. In the Butterfly iQ App, click your avatar at the bottom right corner of the screen to access your Profile and navigate to Notifications.
3. Toggle "Push" to enable push notifications.
4. Navigate to your mobile device's Settings.
5. Select Apps and Notifications.
6. Select Butterfly iQ and allow notifications.

## 4.3. Managing App Updates



### CAUTIONS!

- Butterfly supports the current and two previous releases of the app. Upgrading across multiple versions of the app may require you to uninstall and reinstall the app resulting in possible data loss.
- If the system has not been connected to a wireless or cellular network in the last 30 days, the system prompts you to connect to the Internet for important updates.
- If you ignore the mandatory updates, the system may lock you out.

Butterfly iQ App updates are available in the Apple App Store or Google Play Store.

In your device's settings, you can configure the Butterfly iQ App to update automatically or manually.

If your mobile device is configured to automatically update applications, the Butterfly iQ App updates automatically when an update is available.

If your mobile device is not configured to update automatically, periodically check for updates in the Apple App Store or Google Play Store.

## 4.4. Charging the Probe



### WARNINGS!

- Use only cables, probes, chargers and accessories specified for use with Butterfly iQ+. Substitution of non-approved accessories may cause the system to perform improperly or cause injury to the patient or operator.
- If the probe seems unusually hot, produces an odor or smoke, or leaks, stop use immediately. Unplug the probe from the mobile device or disconnect it from the wireless charger (if applicable). Contact support at [support.butterflynetwork.com](http://support.butterflynetwork.com).
- The probe is designed to remain sealed. Do not attempt to open the probe or tamper with the device internals, including the battery. Doing so may cause injury to the patient or operator.
- The cable on the Butterfly iQ+ is designed to be removed by the user, but the user should check that the cable is fully installed to ensure the probe is protected from the external environment.
- The probe battery is not user-replaceable. Replacement of the battery by parties other than Butterfly Support may result in a hazard such as higher temperatures, fire, or explosion.
- A non-medical grade power supply must be used outside of the patient environment so that it is at least 1.5 meters from the patient.



### CAUTIONS!

- The probe battery should be charged at least monthly to ensure proper functionality.
- If the probe will not power on after charging, it could indicate a battery failure. Contact Support at [support.butterflynetwork.com](http://support.butterflynetwork.com).

It is important to keep your probe charged. Charge your probe with the supplied battery charging accessories.

The battery charging accessories include the charging pad, charging cable, and wall adapter.

**Place the probe on the charger in the orientation shown below**

3rd Generation Probe Charger for Butterfly iQ+



Probe charger



### NOTE

- The latest Butterfly iQ+ charger has a matte black finish. If you have a previous model please visit [support.butterflynetwork.com](https://support.butterflynetwork.com) for additional information on charging your probe.
- Your exact charging pad/charging cable may vary.
- Butterfly iQ+ uses a wireless charging system. Do not attempt to insert your probe's cable into the charging pad or charge via the probe's cable.

Your exact charging pad may vary. For details on the charging pad specifications please visit [support.butterflynetwork.com](https://support.butterflynetwork.com).

### To charge the probe:

1. Disconnect the probe from the mobile device. Imaging cannot be performed while charging.
2. Connect the charging cable to the charging pad and the USB end to the wall adapter.
3. Plug the wall adapter into a power outlet. The charger will light up to show that it is powered on.
4. Place the probe onto the charging pad so that the probe lies flat and wait for the probe's battery indicator lights to turn on.

When the probe battery is charging, the probe battery indicator lights indicate the current battery level. When the probe completes its charge, the probe's battery indicator lights turn off. For additional information on the status lights on your specific charger please visit [support.butterflynetwork.com](https://support.butterflynetwork.com).

**NOTE**

It is normal that the probe may feel warm to the touch while charging. If you remove the probe from the charging pad before or immediately after charging is complete, it is recommended that you allow the probe to cool down before use. Since the system limits patient contact temperature and will not scan at or above 43°C (109°F), allowing the probe to cool down before use will optimize scan time performance.

#### 4.4.1. Checking Probe Battery Level

Use the Battery Indicator Button and Battery Indicator Lights on the probe to check the battery level. For reference, see [Probe \[22\]](#)

**Table 5. Probe Battery Level Indicators**

Light Pattern	Approximate Battery Level
All 4 lights on	87.5% - 100%
3 lights on	67.5% - 87.4%
2 lights on	37.5% - 67.4%
1 light on	12.5% - 37.4%
1st light flashing	<12%

**To check the probe battery level using the probe:**

1. Press the Battery Indicator Button to view the Battery Indicator Lights.
2. If the first button flashes, it indicates that the probe battery charge is too low to perform the study.
3. If the lights do not flash at all:
  - a. Open the Butterfly iQ App.
  - b. Navigate to the scan screen.
  - c. Wait 10 seconds until the “Run troubleshooting” button appears.
  - d. Follow the troubleshooting steps.

**To check the probe battery level using the Butterfly iQ App:**



- The probe battery status is displayed in the upper portion of the imaging screen.
- If the battery charge is too low, you may not be able to perform a study until the battery is recharged. Keep the battery fully charged whenever possible.

## 5. Using the System

This chapter provides information and instructions for using Butterfly iQ+ to begin and end studies. It also provides information and instructions for freezing and unfreezing during live imaging, for performing measurements, and other imaging tools.

### 5.1. Performing a Study

Once the probe is connected to your mobile device follow the prompts on the screen to begin a new study. It is not required to enter patient information to begin a study.

From the main scan screen you can freeze an image , capture still images  and record clips  using the toolbar at the bottom of the screen. The live image must be frozen in order to capture a still image.

Captures may be reviewed from the Capture Reel located in the top right corner of the screen  before the study is completed.

To conclude a patient encounter, click on the capture reel and follow the steps on screen to upload the study.

During scanning, you may swipe horizontally to adjust the gain and swipe vertically to adjust the depth. The Time Gain Compensation (TGC) control button is surfaced upon tapping the screen under the additional controls on the bottom left .



#### NOTE

- You can use the pinch and double-tap gestures to zoom in on an image, and to zoom out on an image. When the image is in a zoomed state, you can use your finger to pan the image (move it around on the screen).
- The ability to rotate from portrait mode to landscape mode while scanning is only available on Tablet devices.

If you do choose to enter patient data in the study, you may do so from the Capture Reel. Depending on your configuration, you may add patient data manually, from a worklist, or by scanning a barcode.

To add or view additional details about the study, such as calculations outputs, utilize the notes field in the Capture Reel.

For additional information on performing a study please visit [support.butterflynetwork.com](https://support.butterflynetwork.com).

## 5.2. Uploading to Butterfly Cloud



### NOTES

- Depending on your platform, hardware, country and membership type, certain presets, modes and features may not be available.
- The Butterfly iQ+ and its accessories may be used multiple times on multiple patients.

#### To archive a study:

1. When you finish capturing ultrasound images, tap the **Capture Reel** in the upper right corner of the screen. The **Study** screen is displayed.
2. OPTIONAL: Associate patient information
3. Tap **Save** to initiate an upload.
4. Select an archive and press **Upload**.
5. To delete all of the items from the Capture Reel, tap **Clear images**. The system prompts you to confirm the deletion. Clearing the series removes all of the images and clips from the Capture Reel.

## 5.3. Using the Probe Button Functionality

When using a Butterfly iQ+ probe, pressing the probe button can result in one of the following actions: capture a still, capture a cine, or unfreeze the image. The probe button push feature is on by default and it could be adjusted from the preferences menu in the Butterfly iQ app.

### 5.3.1. Using the Probe Button Push capture functionality:

**In order to adjust the actions associated with the Button Push for capturing:**

1. Plug in the Butterfly iQ+ probe and enter the Profile menu at the bottom right of the screen by clicking the initials, or your avatar.
2. Select the item "Probe button actions".
3. The capture functionality is enabled by default, to turn it off, toggle "Enable button actions" to the left to deactivate it, or toggle back to the right to activate it again.
4. From the same page you can choose the action associated with pressing the probe button on Butterfly iQ+ during live imaging: the available options are "Capture image" and "Start/stop cine".
5. Return to the scan screen, and start or resume scanning.
6. In order to use the functionality on the Butterfly iQ+ probe, press the button on the probe.

### 5.3.2. Using the Probe Button Push unfreeze functionality:

**In order to adjust the actions associated with the Button Push for unfreezing an image:**

1. Plug in the Butterfly iQ+ probe and enter the Profile menu at the bottom right of the screen by clicking the initials, or your avatar.
2. Select the item "Probe button actions".
3. The unfreeze functionality is enabled by default, to turn it off, toggle the option titled: "Enable button actions" to the left to deactivate it, or toggle back to the right to activate it again.
4. Return to the scan screen, and start or resume scanning.

5. In order to use the functionality, press the button on the Butterfly iQ+ probe to unfreeze when auto-freeze is initiated.



## 6. Using Modes

This chapter provides information and instructions for using modes when performing an ultrasound study.



### NOTE

- Advanced imaging capabilities may vary depending on the selected preset and status of paid subscription. Please visit [support.butterflynetwork.com](http://support.butterflynetwork.com) for the latest details on which preset has access to which modes.
- Butterfly iQ+ or any ultrasound system used for rupture screening of silicone gel-filled breast implants is suitable for asymptomatic patients only. For symptomatic patients or patients with equivocal ultrasound results for rupture at any time postoperatively, an MRI is recommended.

### 6.1. Using B-Mode

The B-Mode is the default image displayed when selecting a preset. The brightness of the individual pixels indicates the strength of the echo reflected signal from the tissue. Some presets, such as Cardiac, have multiple versions of the B-Mode which can be accessed through the presets filter button . One of those presets is called **Coherence**<sup>1</sup>, which uses a different method for calculating the brightness of the pixels based on how much the different signals measured at the aperture are similar to each other, resulting in further suppression of the clutter. Tapping on the filter button again changes the B-Mode image to the standard B-Mode, giving the user the control over the preferred image to use for diagnosis.

### 6.2. Using Color Doppler Mode or Power Doppler Mode

When using Color Doppler or Power Doppler, you can:

- Adjust the size and position of the ROI.
- Adjust the Gain and Depth.
- Adjust the Scale (also known as Pulse Repetition Frequency (PRF)) to optimize for high or low flow by touching the **High/Low** control at the bottom of the screen

The ROI is displayed on the image. To move the ROI, tap and drag the box. To adjust the angle and size, use the arrows provided.

Color gain and depth controls are available during Doppler imaging.

### 6.3. Using M-Mode

M-Mode display includes speed controls (Fast or Slow), the M-Mode line, B-Mode image, and a move point to move the M-Mode line.

When using M-Mode, you can:

- Adjust the radial scan line by tapping and dragging the move point: 
- Adjust the sweep speed of the M-Mode display by touching the Fast/Slow control in the middle of the screen

<sup>1</sup>Cardiac Coherence is not available in all countries.

- Adjust the **Depth** and **Gain**
- Perform time, distance, and heart rate measurements on the display

### Accessing M-Mode

1. Select your desired preset and identify the area you'd like to image. Note that imaging will begin on B-Mode.
2. Select Actions on the bottom of the imaging screen.
3. Under Modes, select M-Mode.

## 6.4. Using Spectral Pulsed-Wave Doppler Mode

Spectral Pulsed-Wave Doppler (Pulsed Doppler) is a quantitative mode that graphically displays blood flow velocity measurements over time.

When using Pulsed Doppler, you can:

- View and adjust the position of the sample volume by holding and dragging the gate.
- View and adjust the angle correction by holding and dragging the white caliper dot.
- Switch between live Pulsed Doppler mode and live B-mode by touching the Start Spectrum/Update B-mode button.
- Adjust gain of spectral trace by dragging finger left and right on the trace while trace is live.
- Adjust the Scale to optimize for high or low flow by touching the **Low Flow/High Flow** control in the middle of the screen. Note that the control defines your current state.
- Adjust the Scroll Speed of the Spectral Doppler trace by touching the **Slow Scroll/Fast Scroll** control in the middle of the screen. Note that the control defines your current state.

In order to adjust the Gain and Depth of the B-mode reference image, exit Pulsed Doppler mode and optimize image in B-mode, Color Doppler mode, or Power Doppler mode.

### Placing the Sample Volume

1. Hold and drag the sample volume gate (the square region in the center of the arrow) to the desired location within the vessel of interest.
2. Once positioned, align the direction of the arrow along the direction of flow. If the flow in the vessel is cranial, point the arrow cranially. An example of an appropriately aligned flow in the Carotid Artery (left) and Internal Jugular Vein (right) is given below.

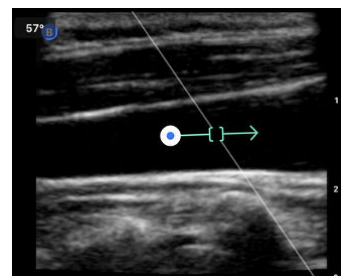
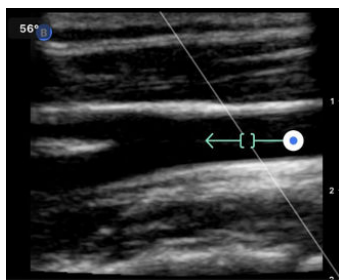

### CAUTION!

Flow directionality is represented relative to the direction of the arrow. Misalignment of the arrow may lead to misinterpretation of flow direction. Carefully check that the arrow is aligned with the expected blood flow direction.

**NOTE**

Flow in the direction of the arrow will always be depicted above the baseline. Flow against the direction of the arrow will always be depicted below the baseline.

3. Tap “Start Spectrum” to start the spectral trace. If you do not see a trace, adjust the position of the sample volume.
4. To adjust the position of the sample volume:
  - a. Hold and drag the arrow, which will automatically pause the spectrum and restart B-mode reference image.
  - b. Tap the Update B-mode button to manually pause spectrum and restart B-mode.
5. To adjust scroll speed of trace, tap the “**Slow Scroll/Fast Scroll**” button.
6. To adjust the velocity scale, tap the button **Low Flow/High Flow** button or drag baseline.
7. To add annotations, freeze the image and tap the annotations button.
8. To add measurements, freeze the image and select linear measurements.

**NOTE**

Annotations and measurements may only be added to the Spectral trace region.

9. Velocity measurements will be represented in cm/s as Peak Systolic Velocity (PSV), the value of the vertical distance from the baseline first caliper dot, and End Diastolic Velocity (EDV), the value of the vertical distance from the baseline of the second caliper dot.
10. The difference in time between the left and right ends of the caliper will be represented as time (t) in seconds.
11. To save a Pulsed Doppler image, freeze then press the capture button.

**NOTE**

To automatically rotate the arrow 180 degrees, tap the invert button when the spectrum is live. If the button is tapped when the spectrum is not live, changes will take effect when the spectrum is restarted.

**Pulsed-Wave Doppler in Abdomen**

For Abdomen and Abdomen Deep, the pulsed wave doppler mode has the following differences compared to what was previously discussed:

- There is no angle correction.
- There is no inversion.
- To move the Sample Volume around, the user can hold on the blue dot . Note: holding in the general vicinity of the blue dot will move the gate as well.

**Pulsed-Wave Doppler in Cardiac**

For Cardiac presets the pulsed wave doppler mode has the following differences geared towards Cardiac applications:

- There is no angle correction.
- There is no inversion.
- Similar to Fetal Heart Sounds, to move the Sample Volume around, the user can hold on the blue dot . Note: holding in the general vicinity of the blue dot will move the gate as well.

- Because the measurements on the Spectrum could be used for any of the peaks, the velocities are generic;  $v_1$  and  $v_2$ .
- Following the convention used in Cardiac Pulsed Wave Doppler, only the absolute value of the measured velocities is shown.

## 6.5. Using Biplane Imaging™

Biplane Imaging is a qualitative mode that displays two planes of imaging, along the longitudinal axis of the probe and the transverse axis of the probe. The longitudinal axis is displayed on the bottom of the screen, called the “reference plane” and the transverse axis is displayed on the top of the screen, called the “perpendicular plane”.

Biplane Imaging is available in the Cardiac Standard, Cardiac Coherence, Musculoskeletal, MSK-Soft Tissue, Nerve, and Vascular: Access presets.

When using Biplane, you can:

- View and adjust the position of the perpendicular plane with respect to the reference plane
- Optimize the gain and depth simultaneously in both planes
- Freeze still images and measure in either viewport
- Capture cines and stills
- Activate Needle Viz (In-Plane) tool

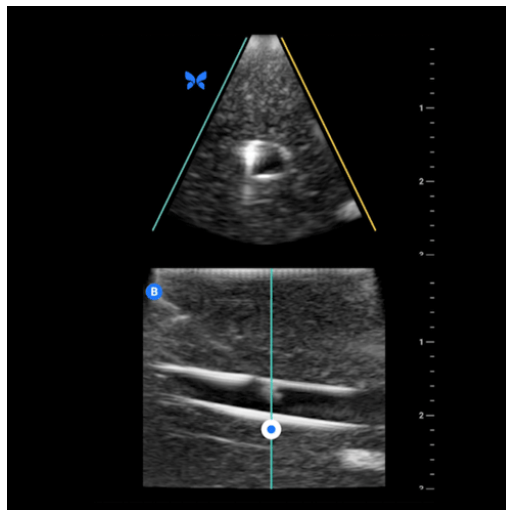

### In order to start using Biplane Imaging:

1. Enter a preset in which Biplane Imaging is available. Activate Biplane from the actions menu
2. Apply gel to the probe and start scanning
3. To adjust the position of the perpendicular plane, touch and drag the white dot side-to-side in the longitudinal (bottom) plane
4. Freeze, measure, annotate, and capture tools, as well as gain and depth adjustment, are available within Biplane
5. To simultaneously use the Needle Viz (in-plane) tool, activate the tool from the actions menu. The reference plane will display the region-of-interest within which an in-plane needle will be highlighted. Additionally, if the needle crosses the perpendicular plane indicator, the position of the needle in the out-of-plane view will be projected upon the perpendicular plane. To flip the position of the region-of-interest, tap the flip button

### Biplane in Cardiac presets

Biplane is available in the following Cardiac presets: Standard and Coherence. Compared to linear presets, the Biplane mode has the following differences:

1. To adjust the position of the perpendicular plane, touch and drag the white dot around the apex of the longitudinal (bottom) plane. move the white dot within the reference plane you can drag it with respect to the longitudinal (reference or bottom) plane, the perpendicular plane will rotate around the apex (top side of the polar image) of the reference plane
2. Both planes are fixed, inversion is disabled, and the orientation is optimized for the parasternal long-axis two-dimensional imaging based on the American Society of Echocardiography (ASE) guidelines<sup>2</sup>.

## 6.6. Using Fetal Heart Sounds

Fetal heart sounds is a mode that allows the user and the patient to hear the sound of the fetus's heart and simultaneously displays the pulsed wave spectrum. Fetal heart sounds is available in the OB 2/3 preset.

When using Fetal Heart Sounds, you can:

- View and adjust the position of the sample volume by holding and dragging the gate.
- Listen to the sound of the fetus's heart when audio is enabled.
- Switch between live audio playing and live B-mode by touching the Start Audio/Update B-mode button.
- Adjust volume of the fetus's heart sound and the gain of spectral trace by dragging finger left and right on the trace while trace is live.
- Adjust the Scale to optimize for high or low flow by touching the Low Flow/High Flow control in the middle of the screen. Note that the control defines your current state.
- Adjust the Scroll Speed of the Fetal Heart Sounds trace by touching the Slow Scroll/Fast Scroll control in the middle of the screen. Note that the control defines your current state.

In order to adjust the Gain and Depth of the B-mode reference image, exit Fetal Heart Sounds and optimize the image in the B-Mode.

### Placing the Sample Volume

1. Hold and drag the sample volume gate (the square region along the Doppler line) to the desired location within the fetus's heart.
2. Once positioned, Tap "Start Audio" to start both the fetal heart sound and the spectral trace. If you do not see a trace or hear a sound, adjust the position of the sample volume.
3. To adjust the position of the sample volume:
  - a. Hold and drag the sample volume gate, which will automatically pause the spectrum and restart B-mode reference image.
  - b. Tap the Update B-mode button to manually pause spectrum and restart B-mode.
4. To adjust scroll speed of trace, tap the "Slow Scroll/Fast Scroll" button.
5. To adjust the velocity scale, tap the button Low Flow/High Flow button or drag baseline.
6. To add annotations, freeze the image and tap the annotations button.
7. To add measurements, freeze the image and select linear measurements.



#### NOTE

Annotations and measurements may only be added to the Spectral trace region.

<sup>2</sup>ASE Guidelines.

8. Velocity measurements will be represented in cm/s.
9. The difference in time between the left and right ends of the caliper will be represented as time (t) in seconds.
10. To save a Pulsed Doppler image, freeze then press the capture button.



#### **NOTE**

- The use of Doppler ultrasound during the first trimester is currently being promoted as an aid for screening and diagnosis of some congenital abnormalities. The procedure requires considerable skill and subjects the fetus to extended periods of relatively high ultrasound exposure levels. Due to the increased acoustic output of spectral Doppler ultrasound, its use in the first trimester should be viewed with caution. Spectral Doppler imaging should only be used when there is a clear benefit/risk advantage, and both the TI and examination duration are kept low. Protocols that typically involve TI values lower than 1.0 reflect minimal risk.

## 7. Annotations

This chapter provides information and instructions for performing annotations on images in the Butterfly iQ App. Annotations can include linear measurements, ellipse measurements, and text annotations.



### 7.1. Adding Annotations

You can add annotations while scanning either from the actions menu or the frozen scan screen. After acquisition, you can add annotations to images and clips in the exam reel.

#### Adding Annotations During Live Scanning

While live imaging, open the Actions menu  and select an annotation to add to the live image.

#### Adding Annotations to Frozen Images

Tap the freeze  icon to first freeze the image. then select the Actions menu .

#### Adding a Text Annotation

1. Under **Labels** either select a preconfigured annotation from the list, or select the "+ Add New" to display the Search or Create New Annotation screen.
2. To use a preconfigured annotation from the search screen, select the annotation.
3. To enter your own annotation, use the keyboard to type the annotation.
4. On your mobile device keyboard, select Done.
5. Drag the annotation to the desired location on the image.
6. To delete the annotation, select it and then select its X. Select Delete Annotation to confirm.
7. You can add up to five text annotations to each image.

#### Performing Linear Measurements

1. Select the **Line** button .
2. Select the blue circles to drag the yellow cross-hairs to the start and end positions of your measurement. As you manipulate the ends of the line, the length (in centimeters) is displayed in a box at the bottom of the image. You can drag this box to the desired location on the image.
3. To add another line, select the Annotation button and select the line symbol again. The next line is displayed in a different color and has a letter next to it. You can add up to four linear measurements to each image.
4. To delete a line, select the line or the line's measurement. Select the X next to the corresponding numeric measurement display, and select Delete Line to confirm.

#### Performing an Area Measurement

1. Select the **Ellipse** button .
2. Touch and drag the caliper icons to scale and rotate the ellipse. A box with the ellipse's circumference and area (displayed in centimeters and square centimeters) is displayed in a box at the bottom of the image. You can drag this box to the desired location on the image.
3. To delete an ellipse, select the ellipse or the measurement value and tap the X next to the corresponding numeric measurement display. Select Delete Ellipse to confirm.

#### Adding Annotations to Images or Clips in the Capture Reel

1. After capturing an image or cine click on the  in the top right corner of the scan screen.
2. Click on the image or clip that you wish to annotate.
3. Click "Edit".
4. Select "Label Capture".
5. Click "Aa" and either click a pre-defined label or type your own.
6. Move the label to the proper place on the image.
7. Click "Save"

## 7.2. Using Protocols

With the Butterfly Protocols, you can follow common exam types and easily label scans of the appropriate views. The available protocols can be found with the relevant presets below:

- Lung Protocol:
  - Lung Preset
  - Pediatric Lung Preset
- Aorta Protocol
  - Aorta & Gallbladder Preset
  - Abdomen Preset
  - Abdomen Deep Preset
- Cardiac Protocol
  - Cardiac Preset
  - Cardiac Deep Preset
  - Pediatric Cardiac Preset
- eFAST Protocol
  - FAST Preset
  - Abdomen Preset
  - Abdomen Deep Preset
- DVT Protocol
  - Vascular Access: Deep Vein Preset

### Adding Labels via Protocols

1. From the scan screen, select the appropriate preset.
2. Open the Actions menu  and press the desired protocol button. The view picker displaying the relevant views for that protocol will appear on the screen.
3. Tap the view you would like to scan.
4. A label will automatically appear at the bottom of the scan screen for the view selected.
5. Capture either a cine or still image.
6. After image capture, the view picker will return. A checkmark indicates that the view has already been captured and labeled.
7. Tap a view to continue labeling.







**NOTE**

All protocol views are optional. You may select any view, including views you have already acquired if you would like to capture multiple examples of that view.

**Editing the Protocol View Label**

1. Tap the view label to activate editing. A pencil will appear next to the label .
2. To move the view label, drag the label to the desired position while editing is active.
3. To change the view, tap the pencil . The view picker will reappear and a new view can be selected.

**Exiting the Protocol**

You can exit the protocol in the following ways:

1. Tapping “Exit workflow” in the view picker
2. Changing the preset
3. Uploading a study
4. Tapping the X next to the Protocol button



**NOTE**

When you exit a protocol, the images captured using the protocol remain saved in the Exam Reel for review and upload. However, the view picker progress will be reset.

## 8. Manual Calculations Packages

This chapter provides information and instructions for using various available calculations packages using the Butterfly iQ+ device and mobile app.





### NOTES

- Depending on your platform, hardware, country and membership type, certain presets, modes and features may not be available.
- The Butterfly iQ+ and its accessories may be used multiple times on multiple patients.

### 8.1. Obstetric Calculations

#### Making an Obstetric Calculation

1. From the scan screen, select either the OB 1/GYN preset or the OB 2/3 preset.
2. Select the Actions menu  on the bottom right corner of the screen.
3. Under the “calculations” heading, inside the OB 1/GYN preset will have: the Crown Rump Length and the Mean Sac Diameter packages will be available. While the OB 2/3 preset will have: Amniotic Fluid Index and Fetal Biometrics packages. Select the one you wish to use.
4. Any imaging mode other than M-mode can be used with these calculations. Once the region of interest is in view, tap the freeze  button.
5. Tap the Actions menu  on the bottom of the screen. New measurement tools corresponding to available inputs to the calculations package will be available.
6. Select the desired measurement, and calipers (linear or elliptical) will appear on the scan screen.
  - a. In the fetal biometrics package, available measurements are biparietal diameter (BPD), head circumference (HC), abdominal circumference (AC), and femur length (FL).
  - b. In the amniotic fluid index package, available measurements are Q1, Q2, Q3, and Q4.
  - c. In the Crown Rump Length package, available measurements are CRL1, CRL2, and CRL3.
  - d. In the Mean Sac Diameter package, available measurements are GSD1, GSD2, and GSD3.
7. Adjust calipers as appropriate. As the calipers are adjusted, the measurement label will adjust to show the input and, if applicable, the gestational age (GA).
8. Once satisfied with caliper placement, tap the confirm button to add the measurement to the report and capture an image.
9. A measurement may be deleted before confirming or unfreezing by selecting the “x” next to the measurement label or the trash can icon in the report.
10. Only one of each input may be added. To edit an input, delete it from the report and re-measure.
11. While in any calculations package, a calculations report is available while the scan screen is frozen.
12. In the fetal biometrics package the report contains:
  - a. AUA: average ultrasound age according to the Hadlock equations
  - b. Hadlock - EDD: Estimating Delivery Date according to the Hadlock equations
  - c. Hadlock - EFW: Estimated Fetal Weight according to the Hadlock equations
  - d. Measurement inputs with corresponding gestational ages (GA)

- e. Patient-reported dates
- 13. In the amniotic fluid index package, the report contains:
  - a. AFI: amniotic fluid index
  - b. Measurement inputs
  - c. Patient-reported dates
- 14. In the Crown Rump Length package, the report contains:
  - a. Gestational age
  - b. Measurement inputs
  - c. Patient reported dates
- 15. In the Mean Sac Diameter package, the report contains:
  - a. Gestational Age according to the Mean Sac Diameter equations
  - b. Estimated Delivery Date according to the Mean Sac Diameter equations



**NOTE**



Mean Sac Diameter should not be solely relied upon to project date of delivery.

- 16. You will exit the obstetric calculations package when you upload your study. To exit an obstetric calculations package before uploading a study, select the X on the bottom of your screen or select the Actions menu and exit by selecting the X underneath. You will be prompted to confirm exporting or deleting of captured measurements if you exit via the Actions menu or the bottom of your screen.
- 17. Once the specified calculation package is exported, the output will be available in the notes field of the study. This can be retrieved and edited in the study reel prior to upload. After uploading the study, notes are available in the archive screen and in the desktop cloud.

## 8.2. Manually Calculate Volume

The manual volume calculation package can be used to generate a volume measurement using the prolate ellipsoid method. This functionality uses the equation  $0.52 * (D1) * (D2) * (D3)$  to calculate volume.

### Manually Calculating Volume

- 1. From the scan screen, select one of the following presets: Abdomen, Abdomen Deep, Bladder, MSK-Soft Tissue, Musculoskeletal, Nerve, or Small Organ.
- 2. Select the Actions button  on the bottom right corner of the screen.
- 3. Under the “Calculations” heading, select Manual Volume.
- 4. When you have identified a view you would like to capture, select the freeze button to freeze the image.
- 5. Tap the Actions button  on the bottom of the screen.
- 6. Select one of the measurements to begin measuring. You will have the option of selecting D1, D2, or D3.
- 7. Adjust calipers as appropriate. As the calipers are adjusted, the measurement label will adjust to show the input.
- 8. Once satisfied with caliper placement, tap the confirm button to add the measurement to the report and capture an image.
- 9. Only one of each measurement may be added. To edit an input, delete it from the report and re-measure.
- 10. At the bottom of the screen, your measurements will be visible. When you take all three measurements, an estimated volume will appear at the bottom of the screen.

11. A measurement may be deleted before confirming or unfreezing by selecting the “x” next to the measurement label or the trash can icon in the report.
12. You will exit the volume calculation package when you upload your study. To exit the calculation package before uploading a study, select the X on the bottom of your screen or select the Actions menu and exit by selecting the X underneath. You will be prompted to confirm exporting or deleting of captured measurements if you exit via the Actions menu or the bottom of your screen.

**NOTE**



Once the volume calculation package is exited, the inputs may not be edited.

13. When the volume calculation package is exported, the output will be available in the notes field of the study. This can be retrieved and edited in the study reel prior to upload. After uploading the study, notes are available in the archive screen and in the desktop cloud.

## 8.3. Gastric Volume Calculation

The Gastric Volume Calculation allows the user to assess the volume of the gastric content.

### Manually calculating the gastric volume

1. From the scan screen select the Abdomen, Abdomen Deep, or the Pediatric Abdomen preset.
2. Select the Actions button  on the bottom right corner of the screen.
3. Under the “Calculations” heading, select **Gastric Volume**.
4. When you have identified a view you would like to capture, select the freeze button to freeze the image.
5. Tap the Actions button  on the bottom of the screen.
6. Select the measurement button to begin measuring. You will have the option of selecting Mean Antero-posterior Diameter (MAD), Mean Craniocaudal Diameter (MCD), and Age.
7. Adjust calipers as appropriate. As the calipers are adjusted, the measurement label will adjust to show the input.
8. Once satisfied with caliper placement, tap the confirm button to add the measurement to the report and capture an image.
9. Only one of each measurement may be added. To edit an input, delete it from the report or the screen and re-measure.
10. At the bottom of the screen, your measurements will be visible. When you take all three measurements, an estimated volume will appear at the bottom of the screen.
11. A measurement may be deleted before confirming or unfreezing by selecting the “x” next to the measurement label or the trash can icon in the report.
12. You will exit the Gastric Volume calculation package when you upload your study. To exit the calculation package before uploading a study, select the X on the bottom of your screen or select the Actions menu and exit by selecting the X underneath. You will be prompted to confirm exporting or deleting of captured measurements if you exit via the Actions menu or the bottom of your screen.

**NOTE**

Once the gastric volume calculation package is exited, the inputs may not be edited.

13. When the volume calculation package is exported, the output will be available in the notes field of the study. This can be retrieved and edited in the study reel prior to upload. After uploading the study, notes are available in the archive screen and in the desktop cloud.

**NOTE**



The gastric volume calculation uses the following two equations depending on the age:

**Table 6. Gastric Volume Equations**

Age range	Equation
>= 18 years	gastric volume (mL) = $27 + 14 * (\text{MAD} * \text{MCD} * \pi / 4) - 1.28 * \text{Age (in years)}$
4-18 years	gastric volume (mL) = $-7.8 + 3.5 * (\text{MAD} * \text{MCD} * \pi / 4) + 0.127 * \text{Age (in months)}$

## 8.4. Carotid Diameter Reduction Calculation

The Carotid Diameter Reduction calculation can be used to measure the percentage of the diameter reduction of the carotid, or any other vessel, by measuring the full diameter of the carotid and the un-obstructed diameter.

1. From the scan screen select the "Vascular: Carotid" preset.
2. Select the Actions button  on the bottom right corner of the screen.
3. Under the "Calculations" heading, select either the **Left Diameter Reduction** or the **Right Diameter Reduction**. Both tools operate in the same way, except one automatically labels the captured images with "Left" and the other one with "Right".
4. For best results it is recommended to acquire the image in the transverse view.
5. When you have frozen an appropriate view, select the Actions button  on the bottom of the screen.
6. You will have the option of selecting Artery Diameter (AD) to measure the full diameter of the artery or the Lumen Diameter (LD) to measure the diameter of the un-obstructed part of the artery.
7. Adjust calipers as appropriate, then select "Confirm" once you are satisfied with caliper placement. Once you confirm, an image will be automatically captured and the measurement will be added to the Notes section of your current study.
  - a. To delete a measurement, select the label and select "x".
  - b. To edit a measurement, delete it from the report and re-add it by following the steps above.
8. Once you've added both measurements, the estimated diameter reduction will appear at the bottom of the screen.
9. You will exit the diameter reduction calculation package when the study is uploaded. To exit the calculation package before uploading a study, select the "x" next to "Left Diameter Reduction" or "Right Diameter Reduction" on the bottom of the scan screen. You will be prompted to confirm exporting or deleting of captured measurements if you exit before uploading your study.

**NOTE**

Once the carotid diameter reduction calculation package is exited, the inputs may not be edited.

10. When the results of the diameter reduction calculation is exported, the output will be available in the Notes field of the study. This can be retrieved and edited in the Study screen prior to study upload.

**NOTE**



The carotid diameter reduction uses the following formula:

$$\text{Diameter reduction (percentage)} = (1 - \text{LD} / \text{AD})$$

## 8.5. Manually calculate angles

The manual angle calculation package (Alpha/Beta) can be used to calculate the acute angle between two lines (an angle that is less than 90 degrees).

### Manually calculate angles

1. From the scan screen, select the Musculoskeletal preset.
2. Select the Actions Button  on the bottom right corner of the screen.
3. Under the "Calculations" heading, either select the "Right Alpha/Beta" or the "Left Alpha/Beta", the Right and Left are there to facilitate labeling the side of the anatomy and both tools work in the same way otherwise.
4. When you have identified a view you would like to capture, select the freeze button to freeze the image.
5. Tap the Actions button  on the bottom right corner of the screen again.
6. Select one of the measurements to begin measuring. You will have the option of selecting **Baseline**, **Alpha line**, or **Beta line**. For a full calculation of an angle (either the Alpha or the Beta), you need either to place the **Baseline** and the **Alpha line** or the **Baseline** and the **Beta line**.
7. Adjust calipers as appropriate. As the calipers are adjusted, if both the **Baseline** and one of the other two lines are selected, the measurement label will adjust to show the calculated angle.
8. Once satisfied with caliper placement, tap the confirm button to add the measurement to the report and capture an image.
9. You can now place the caliper for the other angle.
10. Only one of each measurement may be added. To edit an input, delete it from the report and re-measure.
11. At the bottom of the screen, your measurements will be visible.
12. A measurement may be deleted before confirming or unfreezing by selecting the "x" next to the measurement label or the trash can icon in the report. If you unfreeze or if you select another image from the cine buffer, you will be prompted to export the result to the notes section.
13. You will exit the angle calculation package when you upload your study. To exit the calculation package before uploading a study, select the "x" on the bottom of your screen or select the Actions menu and exit by selecting the "x" underneath. You will be prompted to confirm exporting or deleting of captured measurements if you exit via the Actions menu or the bottom of your screen.
14. When the angle calculation package is exported, the output will be available in the notes field of the study. This can be retrieved and edited in the study reel prior to upload. After uploading the study, notes are available in the archive screen and in the desktop cloud.



### NOTE

If two lines exist with coordinates (x00, y00) and (x01, y01) for the first line, and coordinates (x10, y10) and (x11, y11) for the second line. Then the acute angle between the two lines is given by:

$$Dx0 = x00 - x01$$

$$Dy0 = y00 - y01$$

$$Dx1 = x10 - x11$$

$$Dy1 = y10 - y11$$

$$L0 = \sqrt{Dx0^2 + Dy0^2}$$

$$L1 = \sqrt{Dx1^2 + Dy1^2}$$

$$\text{Angle} = \text{abs}(\cos^{-1}((Dx0 * Dx1 + Dy0 * Dy1)/(L0 * L1))) * 180 / \pi$$

## 8.6. Calculation Package References

1. Gestational Age and Estimated Fetal Weight via Fetal Biometrics
  - a. Hadlock FP, Deter RL, Harrist RB, Park SK. Estimating fetal age: computer-assisted analysis of multiple fetal growth parameters. *Radiology*. 1984 Aug;152(2):497-501.
  - b. Hadlock FP, Harrist RB, Carpenter RJ, Deter RL, Park SK. Sonographic estimation of fetal weight. The value of femur length in addition to head and abdomen measurements. *Radiology*. 1984 Feb;150(2):535-4.
  - c. Anderson NG, Jolley IJ, Wells JE. Sonographic estimation of fetal weight: comparison of bias, precision and consistency using 12 different formulae. *Ultrasound in Obstetrics and Gynecology: The Official Journal of the International Society of Ultrasound in Obstetrics and Gynecology*. 2007 Aug;30(2):173-9.
2. Amniotic Fluid Index
  - a. Phelan JP, Ahn MO, Smith CV, Rutherford SE, Anderson E. Amniotic fluid index measurements during pregnancy. *The Journal of reproductive medicine*. 1987 Aug;32(8):601-4.
3. Crown Rump Length
  - a. Hadlock FP, Shah YP, Kanon DJ, Lindsey JV. Fetal crown-rump length: reevaluation of relation to menstrual age (5-18 weeks) with high-resolution real-time US. *Radiology*. 1992 Feb;182(2):501-5.
4. Mean Sac Diameter
  - a. Daya S, Woods S, Ward S, Lappalainen R, Caco C. Early pregnancy assessment with transvaginal ultrasound scanning. *CMAJ*. 1991 Feb 15;144(4):441-6. PMID: 1993291; PMCID: PMC1452794.
  - b. Equation for gestational age in days:  $(0.882(GS1+GS2+GS2)/3)+ 33.117$
5. Bladder Volume - Prolate Ellipsoid
  - a. Dicuio M, Pomara G, Menchini Fabris F, Ales V, Dahlstrand C, Morelli G. Measurements of urinary bladder volume: comparison of five ultrasound calculation methods in volunteers. *Archivo Italiano di Urologica e Andrologica*. 2005 Mar;77(1):60-2.
  - b. Prolate ellipsoid equation:  $Volume = 0.52 * (D1) * (D2) *(D3)$ .
6. Gastric Volume
  - a. Gastric Volume for  $\geq 18$  years: Van de Putte, P., and A. Perlas. "Ultrasound assessment of gastric content and volume." *British Journal of Anaesthesia* 113.1 (2014): 12-22.
  - b. Gastric Volume for ages 4-18 years: Miller, Andrew F., et al. "Does Point-of-Care Gastric Ultrasound Correlate With Reported Fasting Time?." *Pediatric Emergency Care* 37.12 (2021): e1265-e1269.
7. Carotid Diameter Reduction
  - a. Larsson, Annika C., and Stefan Rosfors. "Diameter-based measurements of the degree of carotid artery stenosis using ultrasonography." *Clinical Physiology and Functional Imaging* 41.2 (2021): 217-220.

## 9. Using the Needle Viz™ (in-plane) Tool



### WARNING!

When used alone, the Needle Viz (in-plane) tool will NOT enhance the visualization of needles inserted out-of-plane.

Needle Viz (in-plane) is a tool that overlays a B-mode image optimized for visualizing needles inserted at a 20-40 degree angle on top of regular B-mode. A region of interest in which the needle may be visualized is represented with a blue-tint, and the location of the region of interest (ROI) may be adjusted using the flip button.

Needle Viz (in-plane) is available in the Musculoskeletal, MSK-Soft Tissue, Nerve, and Vascular: Access presets.

When using Needle Viz (in-plane), you can:

- Adjust the needle approach depth and gain
- Adjust scan depth
- Customize needle gain
- Activate Biplane Imaging



### Using Needle Viz (in-plane)

In order to start using Needle Viz (in-plane):



### NOTE

When using Needle Viz (in-plane) with Biplane Imaging, the position of the needle in the perpendicular plane is only highlighted if the needle is visible in-plane in the reference plane, and therefore in the midline of the perpendicular plane. The needle will be visible in the perpendicular plane, but the appearance will not be enhanced if the needle is not visible in the reference plane.

1. From the scan screen, select the Musculoskeletal, MSK-Soft Tissue, Nerve, or Vascular: Access preset.
2. Select the Actions button on the bottom right corner of the screen.
3. Under the "Tools" heading, select Needle Viz (in-plane).
4. At the bottom of the screen, select "From left" or "From right" to indicate the direction of needle approach.
5. At the bottom of the screen, select 40°, 30°, or 20° to adjust the angle based on the angle of the needle approach.
6. To adjust the gain of the needle, swipe right or left on the screen. If you need to adjust the gain of the image, exit Needle Viz, adjust the gain to your satisfaction, then reactivate Needle Viz.



7. To simultaneously use Biplane Imaging, activate Biplane from the actions menu. The reference plane will display the region-of-interest within which an in-plane needle will be highlighted. Additionally, if the needle crosses the orthogonal plane indicator, the position of the needle in the out-of-plane view will be projected upon the orthogonal plane. To adjust the position of the region-of-interest, tap the flip button.

## 10. AI-Assisted Tools

This chapter provides information and instructions for using AI (Artificial Intelligence)-Assisted tools with Butterfly iQ+.



### NOTES

- Depending on your platform, hardware, country and membership type, certain presets, modes and features may not be available.
- The Butterfly iQ+ and its accessories may be used multiple times on multiple patients.

### 10.1. Butterfly Auto B-line Counter



### NOTES

- Depending on your platform, hardware, country and membership type, certain presets, modes and features may not be available.
- The Butterfly iQ+ and its accessories may be used multiple times on multiple patients.

#### Overview

The Auto B-line Counter provides users with an automatic count of the number of B-lines present within a rib space when using the Lung preset. The Auto B-line Counter uses the Instant Percent method<sup>3</sup> for calculating the maximum number of B-lines present within a single frame of a cine.

#### Contraindications

Not for use in lung zones that contain a large pleural effusion. Not to be used with pediatric patient populations (people below 22 years of age).

#### Compatibility

Auto B-line Counter is supported on all Butterfly iQ+ compatible iOS and Android devices on supported OS versions.

#### Accessing Auto B-line Counter

The Auto B-line Counter can be accessed in the Lung Preset while scanning in B-Mode.

1. On the Presets menu, select the “Lung” preset.
2. Tap **Actions**  located at the bottom right corner of the screen.
3. The Lung actions screen will display.

<sup>3</sup>Anderson et al, “Inter-rater reliability of quantifying pleural B-lines using multiple counting methods,” J. Ultrasound Med. 2013; 32:115–120

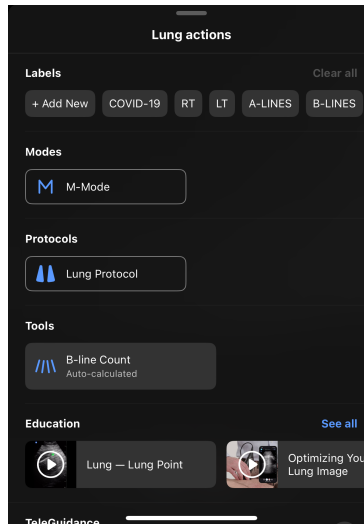

4. Select B-line Count from the Actions menu, under Tools.



**NOTE**

If this is your first time using the B-lines tool, a tooltip will display with instructions on how to use the tool.

5. The Auto B-line counter can be turned off by tapping **X** at the bottom of the screen while the tool is active or tapping the **X** in the Actions menu.

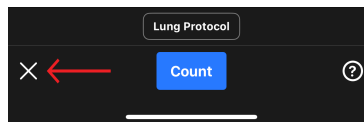

**Calculating B-line Count**



**NOTE**

For general tips about using the Auto B-line Counter, including information about proper probe positioning, tap the ? at the bottom right of the screen.

1. Select B-line Count from the Actions menu within the Lung preset.
2. Position the probe so that the intercostal space between the ribs and the pleural line is in the center of the screen.

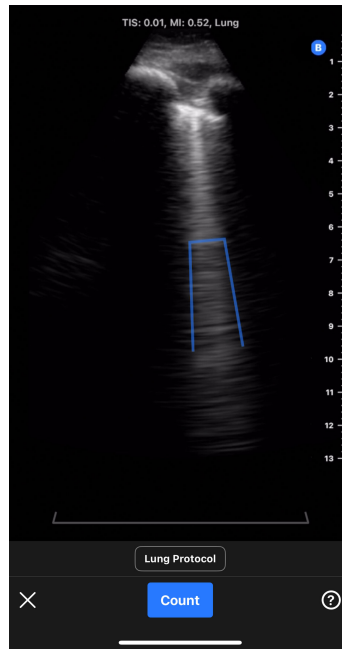

- a. A static, 30-degree sector intercostal space indicator is shown at the bottom of the screen that highlights the area of the image where the B-line count will be measured.
- b. Image gain can be adjusted by swiping left and right on the image.
- c. Image depth can be adjusted by swiping up and down on the image. The image depth cannot be adjusted to be less than 8 cm when using the Auto B-line Counter.
- d. The locations of any detected B-lines are shown in real-time via blue lines overlaid on the image. A single blue line represents a discrete B-line and a blue bracket will highlight areas of confluent B-lines.



**NOTE**

B-line location visualizations should not be used for clinical decision-making.

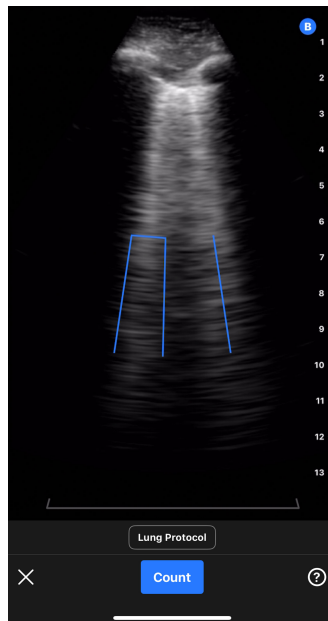

3. Select Count.

- a. A 6 second cine will be captured. A countdown timer will appear in the lower left hand side of the screen. Do not move the probe during the cine recording.
- b. After capturing the cine, the device will prepare the cine and indicate whether automated B-line count is successful.

4. *Auto B-line Counter successfully calculates B-line count*

- a. An automated B-line count is displayed at the bottom of the screen.
  - i. The B-line count represents the maximum number of B-lines present within a single frame within the cine. The Auto B-Line Counter looks across all of the frames in the cine to determine this maximum count. (Note: multiple frames can have the maximum B-line count).
  - ii. The count displayed will be 0, 1, 2, 3, 4, or >5.
- b. The cine above the B-line count displays the images and the B-lines that were identified.

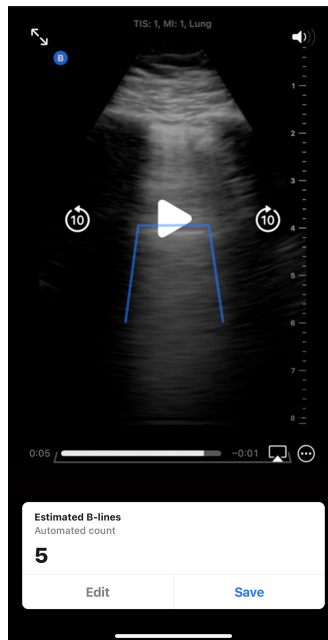

- i. The captured cine will play on a loop. The cine can be paused and frames manually reviewed by tapping the screen and using the playback controls on the screen.
- ii. Identified B-lines will be highlighted by blue lines on the corresponding captured cine. A single line represents a discrete B-line and a bracket will highlight areas of confluent B-lines. B-Line locations are provided as visualization to the user to show how B-Line counts were derived and should not be used for clinical decision-making.

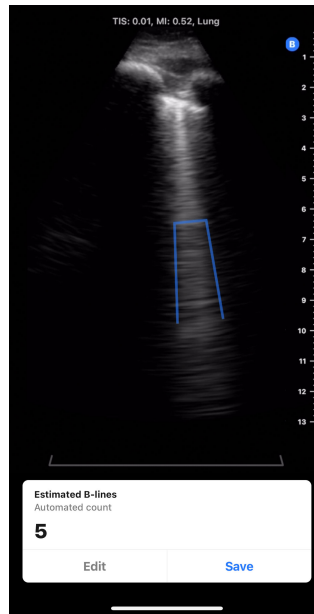

c. Please see the sections below for information on how to edit a B-line count, save the cine, or delete the cine.

5. *Auto B-line Counter unsuccessfully calculates B-line count*

The Auto B-line Counter has the capability of identifying cines that are not adequate for an automatic B-line calculation by the tool based on an internal quality check.

a. In this case, a prompt will display explaining that the tool was unable to obtain an automatic B-line count (see screenshot below). In addition, the automated B-line count will display as “N/A”. Pressing the Continue button will advance to the result screen where a count can be manually added via the Edit button.

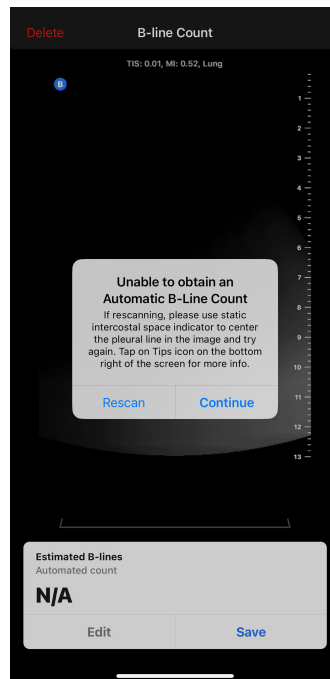

- b. To rescan/repeat the measurement,
  - i. Press the “Rescan” button on the popup window.
  - ii. The device will return to the Auto B-line Counter home screen, where the “Calculating B-line Count” steps can be repeated including capturing a new cine.

- c. To do any other action, including enter a manual B-line count, save the cine, or delete the cine, press the “Continue” button on the popup window.

### Editing the Automated B-line Count

The automated B-line counts for a captured cine can be manually edited by following the steps below.

1. Press the “Edit” button on the Estimated B-lines pop-up window

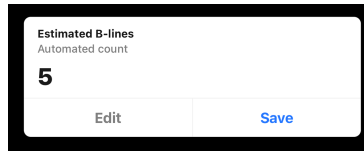

2. When prompted, select “Edit count”

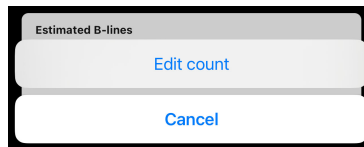

3. Select the desired number of B-lines by using the number picker. The options for manual edits are 0, 1, 2, 3, 4, 5, and >5.

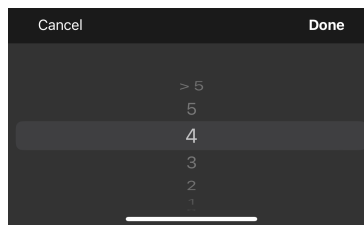

4. If the B-line count is manually edited,
  - a. The count will be marked as a “Manual count” in the Estimated B-lines popup window.
  - b. Any blue lines indicating B-line locations will be removed

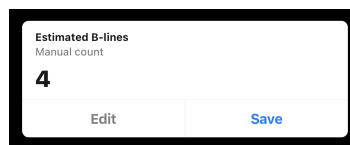

5. The result can be switched back to the automated count by pressing the Edit button again and selecting “Reset to auto count”.

### Saving or Deleting a Captured Cine

A captured cine and B-line count can be either saved to the cine reel or deleted.

1. To save:
  - a. Press the “Save” on the Estimated B-lines pop-up window.
  - b. Once saved, a pop-up will display saying the cine has been saved to the exam reel.
2. To delete:
  - a. Press “Delete” at the top left hand side of the screen.
  - b. The device will indicate that it is deleting the cine and then return to the Auto B-line Counter home screen.

### Using Auto B-line Counter With Lung Protocol

The Lung Protocol can be used with the Auto B-line Counter tool to help label the lung zones being scanned by the user. To turn on the Lung Protocol, click on “Lung Protocol” located above the blue “Count” button. Please refer to the “Using Protocols” section for more information on how to use the Lung Protocol.

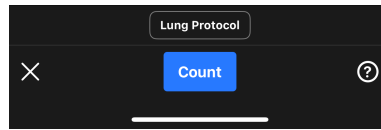

### User Tool Tips

Auto B-line Counter tool tips provide informational tabs with brief, static, standardized information on proper probe placement and how to use the tool. First time users of the Auto B-line Counter are automatically presented with tool tips when they select “B-line Count” from the Actions menu within the Lung preset. Tool tips can be accessed by any Auto B-line Counter user at any time by selecting the ? on the bottom right hand side of the screen when in the tool.



**Position the iQ on the patient.**

- Point blue indicator towards the patient's head.
- Place the iQ in the right mid clavicular line positioned within intercostal space.
- Slide the iQ along the long axis to intercostal space, centering the pleural line between rib and shadow.

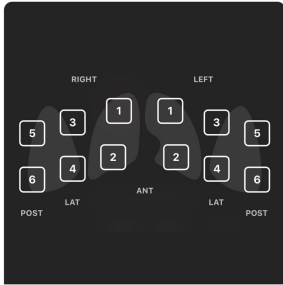

**Choose which zones to scan.**

Turn on Lung Protocol for zone guidance. Select which zones to capture.

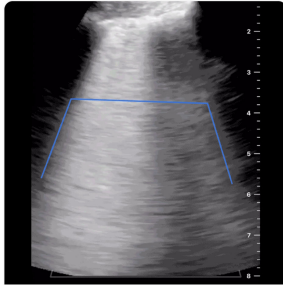

**View B-lines within the detectable rib zone region.**

The rib zone region is shown by the gray horizontal bracket towards the bottom of your screen. B-lines will only be detected within this space.

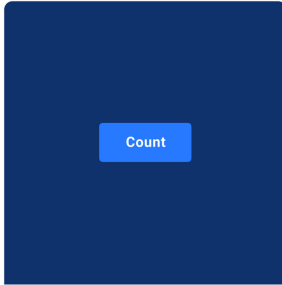

**Tap the “Count” button to obtain the maximum B-line count.**

The scan is counting B-lines over 6 seconds. Keep the iQ steady until scan is complete.

### Accuracy and Limitations of Auto B-line Counter

The Auto B-line Counter uses deep learning algorithms that were trained on thousands of cines from hundreds of sites across the United States. The following inclusion and exclusion criteria filters were applied when selecting and curating datasets for development and clinical validation.

- Only images taken with the standard Lung preset were used.
- Only clinically relevant cines of 8 cm or greater depth were used.
- Studies with pleural effusion were excluded from the dataset.

The Auto B-line Counter uses the Instant Percent method<sup>4</sup> to calculate the greatest number of B-lines in an intercostal space at any instant within a captured cine. The Instant Percent Method counts the number of B-lines in a rib space using the following method:

- Discrete B-lines are counted as 1.
- Confluent B-lines are counted as the percentage of the rib space filled with confluent B-lines divided by 10. For example if 40% of the rib space is filled then the count will be 4.
- The B-line count at any instant/frame is the confluent B-lines and discrete B-lines added together.

<sup>4</sup>Anderson et al, “Inter-rater reliability of quantifying pleural B-lines using multiple counting methods,” J. Ultrasound Med. 2013; 32:115–120



The algorithm examines all of the frames in the cine and determines the maximum B-line count within a frame across the cine loop. This maximum count is displayed to the user as the B-line count for the cine. (Note: It is possible that multiple frames within the cine can have the maximum B-line count.)

The Auto B-line Counter has the capability of identifying cines that are not adequate for automatic B-line calculation based on an internal quality check of the cine. The tool will return a count of "N/A" if this occurs. This may occur, for example, if the pleural line is off-center. In addition to image adequacy, B-line count accuracy can also be affected by operator skill.

**Performance Testing**

Two validation studies were performed to evaluate whether the performance of Auto B-line Counter was non-inferior when compared to clinician annotators (denoted as Study 1 and Study 2). The images collected for these studies represent a broad and distributed cross-section of patients, including a diverse range of B-line counts, age, gender, body mass index, ethnicity, and race<sup>5</sup>.

**Study 1 Description:** The objective of Study 1 was to demonstrate the Auto B-line Counter is non-inferior to clinician annotators (Ground Truth). The primary endpoint was the inter-rater correlation coefficient (ICC) between the B-line scores from the Auto B-line Counter tool and the B-line scores from the Ground Truth. The secondary endpoint was the Dice Similarity Coefficient between the centroid-paired segmentation from the Auto B-line Counter tool and the segmentation from the Ground Truth. Study 1 was a retrospective analysis of de-identified lung ultrasound cines collected during the standard usage of the Butterfly iQ and Butterfly iQ+ products, uploaded to the Butterfly Cloud. This data comes from the population of providers using Butterfly devices in concert with the Butterfly Cloud application in the real world. The clinical validation dataset consists of 253 de-identified six-second cines from 109 clinical sites. The data was from patients aged 22 through 90 with balanced distribution across gender.

**Study 2 Description:** The Auto B-line Counter Algorithm Clinical Performance Evaluation was a supplemental validation study designed to demonstrate the generalizability of the Auto B-line Counter across the relevant patient demographic categories. The primary endpoint of this study was to demonstrate the Auto B-line counter algorithm performance is non-inferior to consensus clinician interpretation (Ground Truth). The secondary objective of this study was to evaluate the algorithm’s performance among diverse subgroups of age, gender, BMI/habitus, ethnicity, and race. The primary endpoint was the inter-rater correlation coefficient (ICC) between the Auto B-line Counter tool and the Ground Truth equal. Study 2 was a retrospective secondary data analysis of de-identified lung ultrasound cines and subject demographic information collected from a single site during an IRB-approved study. Data was collected from patients 22 years old or older that consented to participate in the study, and were included based on their history of admission to a general care, telemetry, or moderate care unit with clinical concerns that included pulmonary congestion. All patients enrolled in the study received lung ultrasound exams with the Butterfly iQ/ iQ+ Ultrasound system with the Lung preset. All cines were saved in the Butterfly Cloud. The data was curated to cines from 97 unique subjects. The non-identifying subject demographic data collected included age, gender, height and weight (for BMI), ethnicity, and race; these are summarized in the table below.

**Table 7. Demographic breakdown of Study 2, n=97**

Category	# of subjects
<b>Age (years)</b>	
22 - 42	12
42 - 62	31
62 - 82	45
82 - 90	9
<b>Gender</b>	
Male	41
Female	56
<b>BMI</b>	

<sup>5</sup>The definition and division into ethnicity and race are per the Office of Management and Budget: Standards for the Classification of Federal Data on Race and Ethnicity (June 9, 1994) and required by the FDA Safety and Innovation Act (Public Law No. 112-114 (February 9, 2012) SEC. 907. REPORTING OF INCLUSION OF DEMOGRAPHIC SUBGROUPS IN CLINICAL TRIALS AND DATA ANALYSIS IN APPLICATIONS FOR DRUGS, BIOLOGICS, AND DEVICES.

Category	# of subjects
<25 kg/m <sup>2</sup>	27
25-30 kg/m <sup>2</sup>	22
30 kg/m <sup>2</sup> or higher	48
<b>Ethnicity<sup>5</sup></b>	
Hispanic or Latino	2
NOT Hispanic or Latino	91
Unknown / Not Reported	4
<b>Race<sup>5</sup></b>	
American Indian/Alaska Native	1
Black or African American	22
White	73
Unknown / Not Reported	1

**B-line Count Performance:** In both studies the inter-rater correlation coefficient (ICC) was calculated between the Auto B-line Counter’s B-line count predictions and the ground truth. Ground truth was defined as the median of 9 expert annotators on the same set of cines. Both tests exceeded the performance goal of demonstrating an ICC above a lower bound of 0.75. The performance target was derived from published literature<sup>6</sup>.

	Acceptance Criteria	ICC	95% CI
Study 1 Results	ICC 0.75	0.899	[0.867, 0.92]
Study 2 Results		0.85	[0.78, 0.90]

*B-line Count Subgroup Analysis (Study 2)*

Study 2 assessed the generalizability of the Auto B-line Counter across a wide range of clinically meaningful patient subgroups (age, gender, BMI, ethnicity, and race). The tool performed similarly across all subgroups.

**B-line Visualization (aka B-line Segmentation) Performance:** Using Study 1 only, the degree of overlap in localizing the position of B-lines was assessed using the Dice Similarity Coefficient (DSC) between the centroid-paired segmentation from the Auto B-line Counter tool and the segmentation from the Ground Truth was calculated. Ground truth for B-line segmentation was determined using 7 expert annotators. The DSC was calculated between a B-line identified by the tool and a ground truth B-line that had complete or partial overlap, or abutted against one another with no overlap. Study 1 exceeded the performance goal of demonstrating the DSC was equal or larger than 0.52. The performance target was derived from published literature<sup>7</sup>.

	Acceptance Criteria	DSC	95% CI
Study 1 Results	DSC 0.52	0.82	[0.78, 0.876]

## 10.2. Automatically Estimating Ejection Fractions



**NOTE**

The Simpson's Ejection Fraction tool is not available in the United States.

<sup>6</sup>This approach follows that of an analysis of an AI/ML-based B-line counter algorithm described by Moore et al., “Interobserver Agreement and Correlation of an Automated Algorithm for B-Line Identification and Quantification With Expert Sonologist Review in a Handheld Ultrasound Device,” J Ultrasound Med 2021.

<sup>7</sup>Derived from two papers: 1) Mason, Harry et al. “Lung Ultrasound Segmentation and Adaptation between COVID-19 and Community-Acquired Pneumonia,” 2021, Accepted to MICCAI ASMUS Workshop (<https://doi.org/10.48550/arXiv.2108.03138>). 2) Roy, S. et al., “Deep Learning for Classification and Localization of COVID-19 Markers in Point-of-Care Lung Ultrasound,” in IEEE Transactions on Medical Imaging, vol. 39, no. 8, pp. 2676-2687, Aug. 2020, doi: 10.1109/TMI.2020.2994459.

The Simpson's Ejection Fraction tool allows you to estimate left ventricular Ejection Fractions (EF) when capturing cardiac studies from an apical four chamber view of the heart. Butterfly iQ uses the Simpson's Monoplane<sup>8</sup> method to calculate the ejection fraction.

### Compatibility

The Automatic Ejection Fraction Tool is supported on all Butterfly iQ+ compatible iOS devices, on supported OS versions.

The Automatic Ejection Fraction Tool is not supported on Android devices.

### Using the Automatic Ejection Fraction Tool

1. Select the Cardiac preset.
2. Select the Actions button  on the bottom of your screen.
3. Under tools, select Simpson's EF.

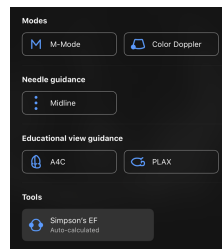

4. The Record an Apical 4 Chamber screen is displayed with an Educational View Guide at the bottom of the screen. The guide uses a scale from red to green , with green indicating a high quality image. Position the probe to acquire a high quality apical 4 chamber view of the heart.





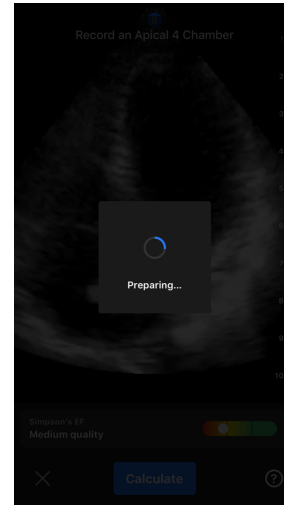
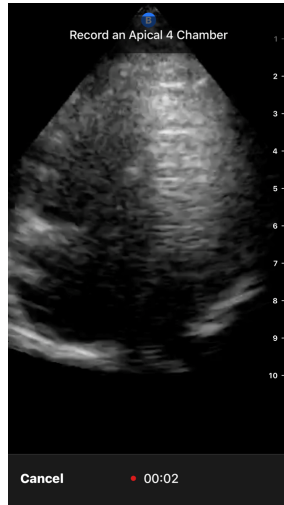

5. Select Calculate and hold the probe steady. A 3-second clip is automatically recorded.

<sup>8</sup>Lang et al., J. Am. Soc.Echocardiography, 2005: 1440-63. Estimates of the base points of the mitral valve `points` are used to define the midpoint of the mitral valve and the apex point (furthest point on segmentation mask from midpoint). These two points define an axis about which we perform disk integration. As per convention, 20 disks should be used.

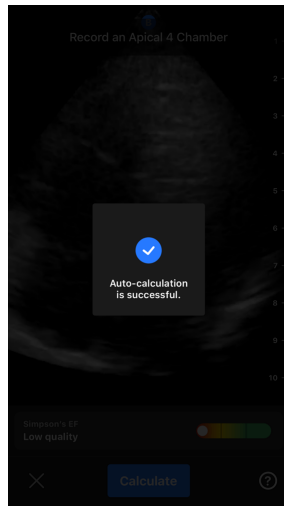

6. If the automatic EF tool is able to calculate an Ejection Fraction, the Automatic Ejection Fraction result screen is displayed, and the calculated Ejection Fraction is marked as an Auto-calculated Simpson's measurement. You have the option to either save this automatic result, edit the result and recalculate, or delete the result and cine.



7. If the tool is not able to calculate an Ejection Fraction or you choose to edit your result, you will be directed to the Edit screen. There, you have the ability to adjust the End Diastole (ED) frame and left ventricle contour.
  - a. Scroll through the frames on the bottom of the screen to the appropriate frame for ED.
  - b. To move the overall position of the contour used to measure the ventricle, press and drag the white anchor point . Release the anchor point when the contour is in the appropriate position.
  - c. To alter the position of the contour sides used to measure the ventricle, press and drag the blue circle that indicates an adjust point  around the contour. Release the adjust point when the contour is in the appropriate position.
  - d. To alter the position of the contour apex, press and drag the Apex Adjust Bar  at the top of the contour. Release the Apex Adjust Bar when the contour is in the appropriate position.
  - e. Once edits are complete, select Update ED.

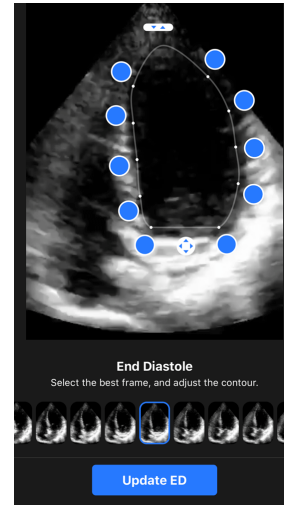
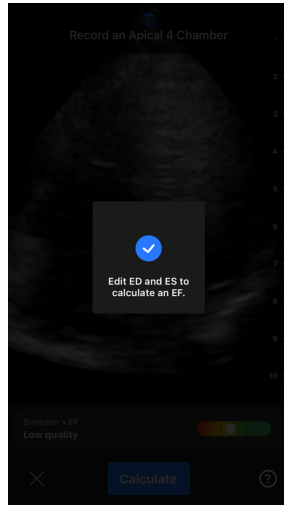

- Follow the same process as above for End Systole (ES), and select Update ES when complete. The Ejection Fraction result screen is displayed and the calculated Ejection Fraction is marked as a manual Simpson's Method measurement.

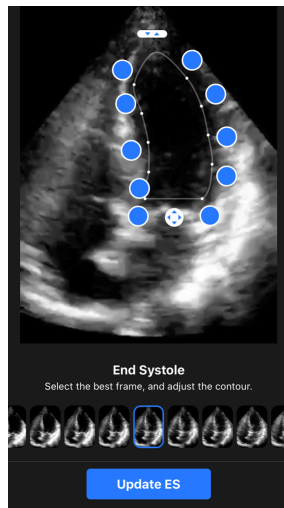

- If you select Save to save the measurement, the captured 3-second cine loop with the Ejection Fraction estimated and associated ED and ES left ventricle contours are saved to the Capture Reel. Note that selecting Delete deletes both the Ejection Fraction result and the 3-second cine used to calculate the result.

### 10.3. Automatically Estimating Bladder Volume

#### Indications for Use

The Butterfly Auto Bladder Volume Tool is a software application package. It is designed to view, quantify and report results acquired on Butterfly Network ultrasound systems for noninvasive volume measurements of the bladder, to support physician diagnosis. Indicated for use in adult populations.

#### Contraindications

Not intended for fetal or pediatric use or for use on pregnant patients, patients with ascites, or patients with open skin or wounds in the suprapubic region.

#### Calculating a Bladder Volume

The Auto Bladder Volume tool<sup>9</sup> allows you to calculate bladder volume when you are using the Bladder preset in B-mode. The Butterfly iQ+ has the capability to acquire a 3D sweep while you hold the probe steady. A volume estimate is then calculated from this 3D sweep.

### Accessing the Auto Bladder Volume tool from within a preset

1. Tap the Actions icon  located at the bottom right corner of the screen.
2. Select the Volume option.

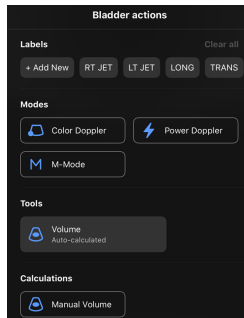

3. Tap X to turn off the Auto Bladder Volume tool.

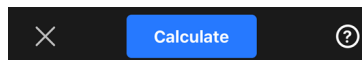

### Calculating Bladder Volume



#### NOTE

For help using the Auto Bladder Volume tool, including information about proper probe positioning, tap  at the bottom right of the screen.

1. Select **Volume** from the Actions menu within the **Bladder** preset.
2. Position the probe so that the bladder appears at its widest and is centered on the screen. A blue shape highlights when the Auto Bladder Volume tool detects a bladder, and the center of the blue shape is marked with a . Use the vertical line down the center of the screen to help you center the bladder.

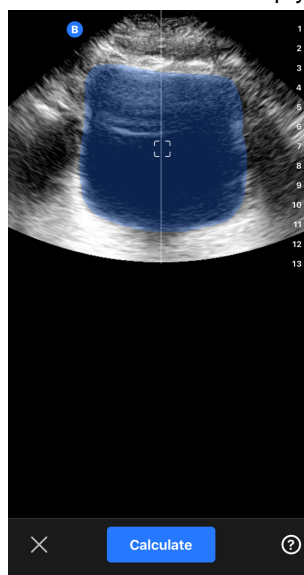

<sup>9</sup>Ronneberger, Olaf, Philipp Fischer, and Thomas Brox. "U-net: Convolutional networks for biomedical image segmentation." International Conference on Medical image computing and computer-assisted intervention. Springer, Cham, 2015.

3. Select **Calculate**. A 3D sweep of the bladder area is automatically acquired. Do not move the probe during the sweep.
4. After successfully capturing the bladder, a volume is displayed at the bottom of the screen. The cine above the volume result displays the images and estimated bladder used to calculate the volume.

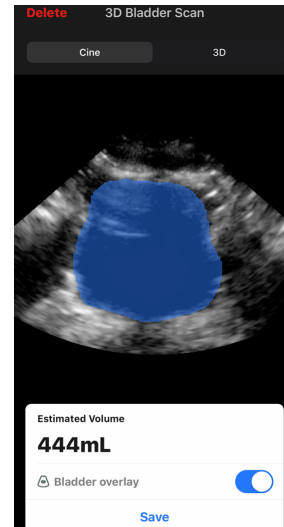
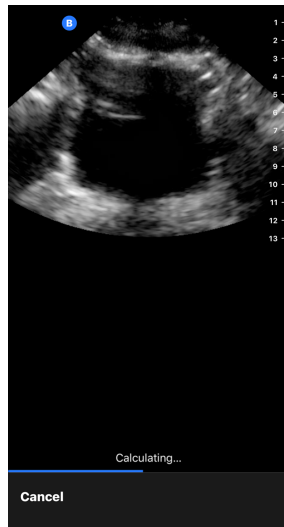

**NOTE**

You can disable the blue bladder highlight by tapping the Bladder Overlay toggle.

5. Tap the 3D bar to visualize an interactive 3D render of the bladder.

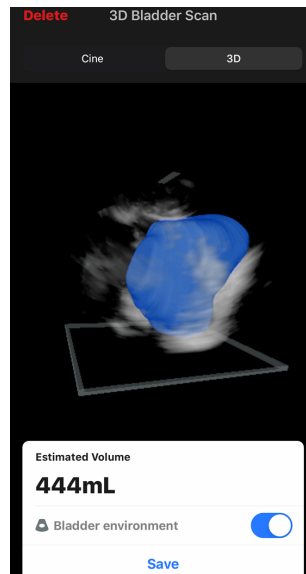

**NOTE**

The 3D render is not for diagnostic use.

**Saving an Automatically Estimated Bladder Volume**

The Auto Bladder Volume tool allows you to save the estimated volume result for review in the Butterfly iQ Mobile App and Butterfly Cloud.

1. Select Save from the bottom of the Bladder Volume result screen. The captured cine loop with the bladder volume estimate and bladder out line is saved to the Capture Reel.

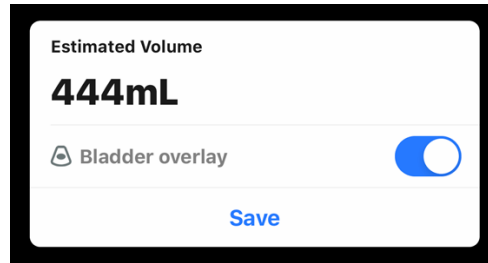

### NOTE

Selecting Delete deletes both the bladder volume result as well as the cine used to calculate the result.

### User Tool Tips

First time users of the Auto Bladder Volume tool are presented with tips on using the tool. These informational tabs can be accessed by any Auto Bladder Volume tool user at any time by selecting  when in the tool.

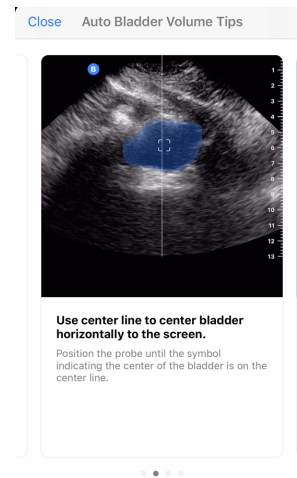
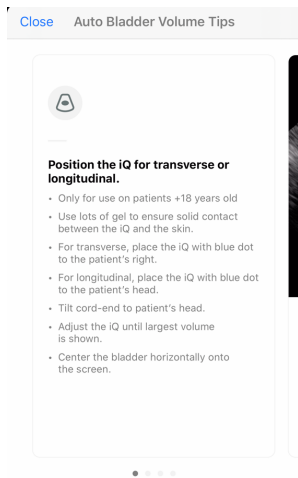



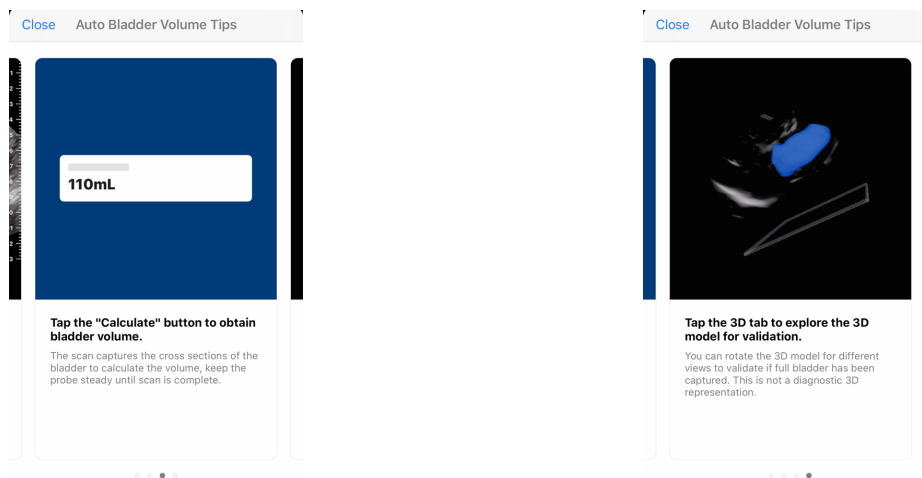

**Table 8. Volume Measurement Accuracy**

Volume Range	Specification
0-100mL	±7.5 mL
101-740 mL	±7.5 %

- The measurement accuracy specifications assume the tool is being used to scan a tissue-equivalent phantom as instructed.
- The volume range of the 3D Auto Bladder Volume Tool is 0-740ml. Although higher volumes may be estimated and displayed, Butterfly Network cannot guarantee the accuracy of measurements outside of this stated range.

## 10.4. Butterfly iQ Educational View Guidance



### CAUTION!

The Educational View Guidance tools are for Educational Use Only. Not intended for clinical or diagnostic use.



### NOTE

Educational View Guidance is not available in the United States.

The Educational View Guidance tools provide users with a visual indication of the quality of the image while scanning with the Butterfly iQ+. The Educational View Guidance tools support the following views:

- Cardiac Apical 4 Chamber
- Cardiac Parasternal Long Axis
- Cardiac Parasternal Short Axis
- Lung A-Lines/B-Lines

As you scan the subject, the tool provides real-time feedback on image quality using a red to green scale, with green indicating a high-quality image . It indicates the proportion of experts who would assess the anatomical view as measurable.

### Accessing Educational View Guidance

The Educational View Guidance tools can be accessed in the Cardiac or Lung Preset while scanning in B- Mode.

Tap Actions  located at the bottom right corner of the screen. You have the option to select the following tools from the Educational View Guidance section:

- Cardiac preset: A4C (Apical 4 Chamber), PLAX (Parasternal Long Axis) and PSAX (Parasternal Short Axis).
- Lung preset: A-Lines/B-Lines.

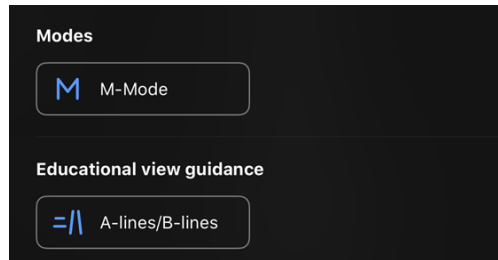

The Educational View Guidance tools can be turned off by tapping X on the tool while scanning in B-mode or in the Actions menu.

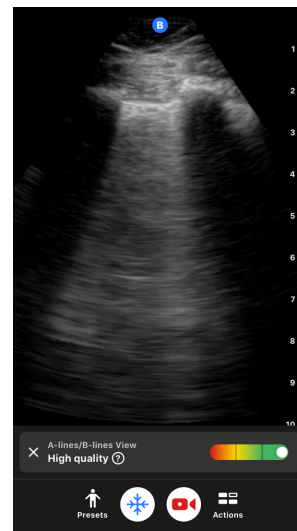
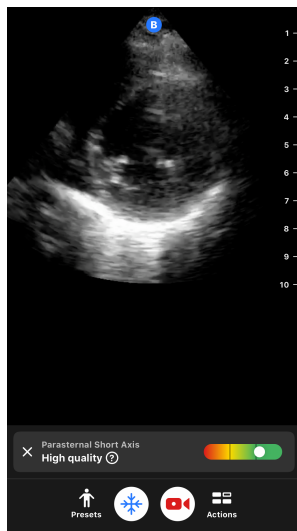

For additional information on Educational View Guidance, and the latest device compatibility, please visit [support.butterflynetwork.com](https://support.butterflynetwork.com).

# 11. Using Butterfly Cloud

This chapter provides information and instructions for using Butterfly Cloud to store and access ultrasound exams uploaded from the Butterfly iQ App.



## NOTE

Your organization may choose to configure Butterfly Cloud using Single Sign On (SSO). SSO is part of Butterfly Enterprise. For additional information on Butterfly Enterprise and enabling SSO configurations please visit [support.butterflynetwork.com](https://support.butterflynetwork.com).

## 11.1. Overview

Butterfly Cloud is a web-based application that allows users to upload and review ultrasound exams from the Butterfly iQ App. Users of the cloud can also document, bill and integrate Butterfly iQ+ into existing hospital systems such as a PACS, VNA, EMR, or Modality Worklist. Butterfly Cloud also supports the acceptance of images from third-party ultrasound devices.

A Butterfly Cloud Administrator configures the archives, adds new members, and sets user access levels. Administrators can also configure external connections to Butterfly Cloud.

For additional information on Butterfly Cloud please visit [support.butterflynetwork.com](https://support.butterflynetwork.com).

## 11.2. Accessing Butterfly Cloud

Butterfly Cloud can be accessed from both the Butterfly iQ App as well as a desktop web browser at [cloud.butterflynetwork.com](https://cloud.butterflynetwork.com). If you are a Butterfly Enterprise user, navigate to [\[YourDomain\].butterflynetwork.com](https://[YourDomain].butterflynetwork.com).

Log in to Butterfly Cloud with your Butterfly email and password or Single Sign On (SSO) credentials.

## 11.3. Viewing and Managing Studies

### Viewing a Study

1. Log in to Butterfly Cloud.
2. Select the archive (folder) where the study was uploaded.
3. Click on the study to view detailed patient information and review the images and clips.

### Moving a Study to a New Archive

1. Log in to Butterfly Cloud.
2. Locate the study that you would like to move. Studies can be moved from the archive screen, or the study detail view.
3. In the top right corner of the study, click the "More" drop-down menu to display the menu. If you do not see "Move Study" please contact your Butterfly account administrator to gain additional access.
4. Select the archive that the study should be moved to.

### Deleting a Study

1. Log in to Butterfly Cloud.

2. Navigate to the archive that contains the study you want to move.
3. In the top right corner of the study, click the "More" drop-down menu to display the menu.
4. Select "Delete study." The system prompts you to confirm the deletion.
5. Click "Delete" to delete the study.

For additional information please visit [support.butterflynetwork.com](https://support.butterflynetwork.com).

## 12. Using Butterfly TeleGuidance

This chapter provides information regarding Butterfly TeleGuidance. The service enables users to call one of your available connections through your Butterfly iQ App for remote collaboration while scanning.



### NOTES

- Depending on your platform, hardware, country and membership type, certain presets, modes and features may not be available.
- The Butterfly iQ+ and its accessories may be used multiple times on multiple patients.

### 12.1. Overview

A TeleGuidance call requires both a scanner and remote collaborator.



### CAUTION!

- Butterfly TeleGuidance must only be used between two healthcare professionals.
- PHI will be visible to users who accept calls.
- Network conditions can degrade the quality of image and video for remote collaborators

#### To make a call, as local scanner — on iPhone or iPad

On iOS, click the Actions button on the bottom right of the main scanning screen and then the phone icon on the TeleGuidance row in the bottom right. Select an online connection to call.

#### To receive a call, as remote collaborator — on a computer running Google Chrome browser

In Google Chrome on a desktop computer log in at [cloud.butterflynetwork.com](https://cloud.butterflynetwork.com). If you are a Butterfly Enterprise user, navigate to [YourDomain].butterflynetwork.com and log in. Click “TeleGuidance” in the top navigation bar. Make yourself available for calls and make sure your speakers are turned on. When a call comes in, a ringtone will play and an alert will appear on the webpage. Accept the call to begin.

For additional details on how to perform Butterfly TeleGuidance sessions please visit [support.butterflynetwork.com](https://support.butterflynetwork.com).

## 13. Using Butterfly iQ+ Care

This chapter provides information regarding Butterfly iQ+ Care. The feature enables new workflows with a simplified scanning UI designed for repeated use of specific applications.



### NOTES

- Depending on your platform, hardware, country and membership type, certain presets, modes and features may not be available.
- The Butterfly iQ+ and its accessories may be used multiple times on multiple patients.

### Overview

Butterfly iQ+ Care requires a [compatible device](#) and access to the Butterfly iQ+ Care suite of features.

### To take a bladder volume measurement - on iPad



### NOTE

See [Automatically Estimating Bladder Volume \[61\]](#) for important information, including indications for use and contraindications.

1. Plug-in the probe
2. Tap on the “Bladder scanner” button if available
3. Optionally, enter patient details if available
4. On the calculate screen, place the probe on the bladder, center the bladder and press calculate

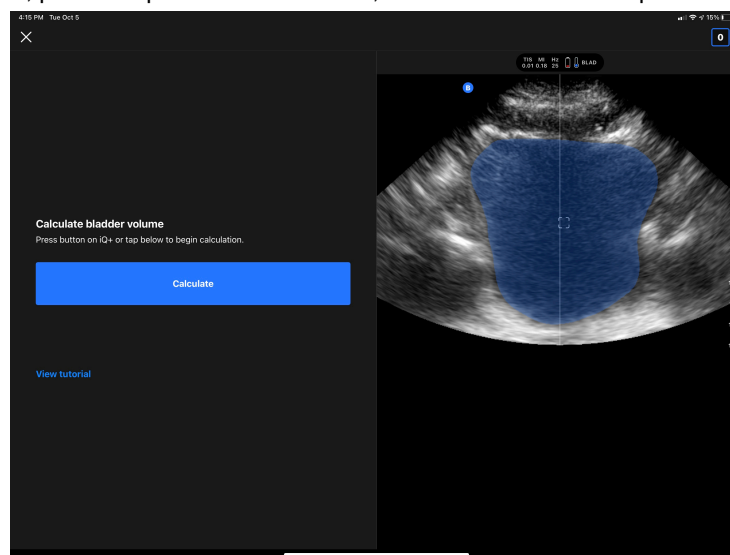

5. Optionally, view tutorial which contains a video and a step by step walkthrough of a bladder scan



**NOTE**

This tutorial is not a substitute for professional clinician training and experience and may not include all possible patient to patient variation. Clinicians are solely responsible for patient care and for exercising their independent clinical judgment at all times.

6. On the results screen, tap finish to upload or go to exam reel to review the study
7. Optionally, tap restart to start over. Restarting will preserve your previous scan

**To perform a vascular access scan - on iPad**

1. Plug-in the probe
2. Tap on the “Vascular access” button if available
3. Optionally, enter patient details if available
4. Enable tools such as Needle Viz or Biplane from the Actions menu

## 14. Using Butterfly iQ+ Bladder System

This chapter provides information regarding the Butterfly iQ+ Bladder system. This system provides healthcare providers with a streamlined workflow for bladder scanning applications.



### NOTES

- The Butterfly iQ+ Bladder system is not available in all countries.
- The Butterfly iQ+ Bladder experience requires a dedicated probe (the Butterfly iQ+ Bladder), and it is not compatible with the Butterfly iQ/ iQ+/ iQ3.
- The Butterfly iQ+ Bladder system is only available on Apple iPads with a USB-C port. See [here](#) for a full list of compatible devices.
- The Butterfly iQ+ Bladder system is limited in depth between 5 cm and 20 cm.

### 14.1. Overview

The Butterfly iQ+ Bladder requires a compatible device and compatible software. It is recommended to always install the latest version of the app. The Butterfly iQ+ Bladder probe is a configuration of the Butterfly iQ+ hardware platform, and thus shares its mechanical and electrical specifications. The Butterfly iQ+ Bladder offers the user to acquire volume measurements through the Auto Bladder Volume Tool or the manual volume calculation package.



### NOTE

The Butterfly iQ+ Bladder does not require a login and does not save images as such no PHI/PII is stored on the device when operating the Butterfly iQ+ Bladder system.

### 14.2. Indications for Use

The Butterfly iQ+ Bladder Ultrasound System is indicated for use by trained healthcare professionals in environments where healthcare is provided to enable diagnostic ultrasound imaging for the measurement of fluid volume of adult and pediatric patients for the clinical application of urology.

The ultrasound mode of operation is B-Mode.

### 14.3. Contraindications

The Auto Bladder Volume Tool is not intended for fetal or pediatric use or for use on pregnant patients, patients with ascites, or patients with open skin or wounds in the suprapubic region.

### 14.4. Acquiring a Bladder Volume

By default, the Manual Volume Calculation Package will be disabled. To enable this feature, navigate to the settings screen, click “Manual Calculation”, and click “Enable Manual Calcs”. When Manual Calculation Package is enabled, you will be presented with a screen to select between Auto Bladder Volume and Manual Volume.



### 14.4.1. Acquiring a Bladder Volume with Auto Bladder Volume Tool

The Butterfly Auto Bladder Volume Tool is a software application package. It is designed to view, quantify and report results acquired on Butterfly Network ultrasound systems for noninvasive volume measurements of the bladder, to support physician diagnosis. Indicated for use in adult populations.

1. Make sure the probe is connected to a compatible iPad.
2. Turn on the iPad.
3. Select the app; if the probe is connected, the system will start loading.
4. Once the system loads you will be presented with a quick tips card. On this screen you will be able to start scanning by tapping on **“Start Scanning”** or start scanning with tips by tapping on **“More help”**.
5. On the scan screen you will have a live image which utilizes the Auto Bladder Volume tool for segmenting the bladder. Moreover, you can enable tips on the left side of the screen by tapping on , when the tips are enabled you will be able to scan the bladder alongside useful tips on best practices when it comes to scanning a bladder.
6. Within the live view, you can adjust the depth by swiping your finger up and down on the screen. It is recommended that you center the bladder in the field of view before you start scanning. Refer to the chapter on [Auto Bladder Volume](#).

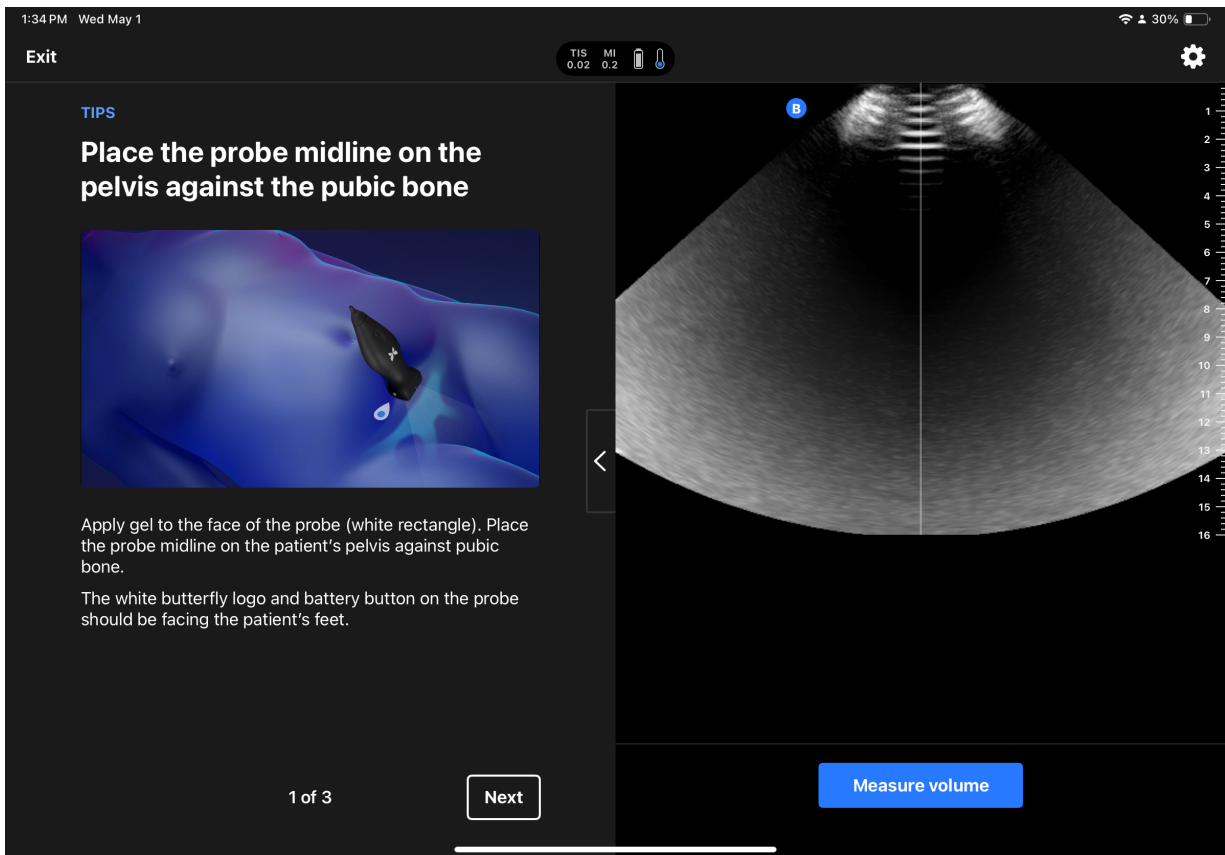

7. Once you find the bladder, you can initiate a measurement either by pressing on **“Measure volume”** or by pressing on the probe battery button. The app performs a 3D sweep and utilizes the [Auto Bladder Volume](#).
8. Once you acquire a volume, you will be presented with a screen showing the volume, as well as a 3D rendering of the volume for review.

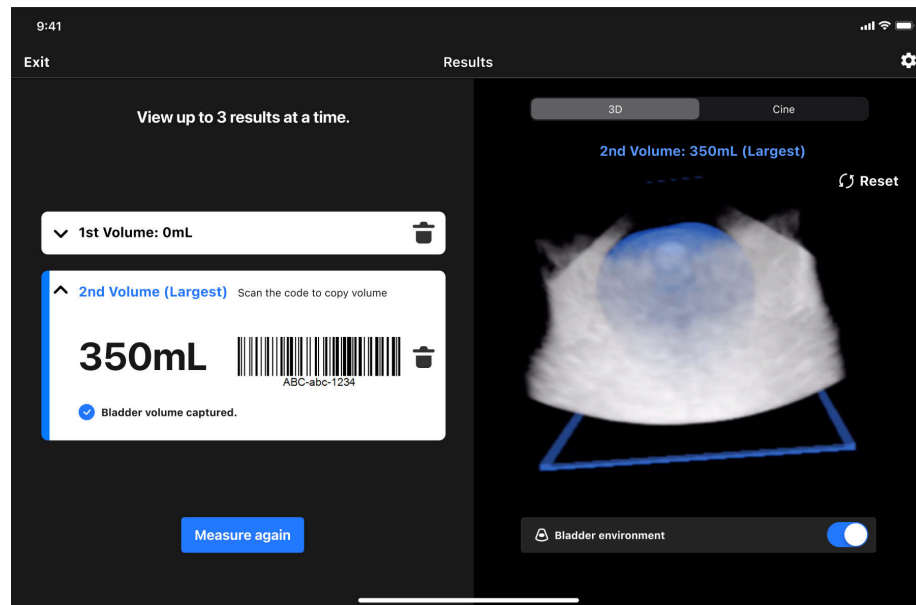

9. From the review screen, you can capture up to 3 measurements and use the maximum measurement, or exit to the main screen and start a new scan session. Each of the measurements has a barcode associated with it, which you can scan into an EHR system. The type of code can be configured in the settings menu.
10. Once done, you can exit the scan by tapping on “**End Scan**” in the top left corner of the screen.



#### NOTE

Once you end the scan, the images will be deleted permanently.

### 14.4.2. Acquiring a Bladder Volume with the Manual Volume Calculation Package

Users may calculate the bladder volume using the Manual Volume Calculation Package, which uses the Prolate Ellipsoid method to calculate the the volume  $0.52 * (D1) * (D2) * (D3)$ . Refer to the chapter on [Manual Calculation Package \[42\]](#).

1. Make sure the probe is connected to a compatible iPad.
2. Turn on the iPad.
3. Select the app; if the probe is connected, the system will start loading.
4. When starting an exam, select “Manual Calculation”
5. The app will now walk you through the acquisition of two bladder images (transverse and longitudinal) and three measurements across those images.
6. Exam Step 1 of 5: First, the app will walk you through the transverse image capture. On the scan screen you will have a live image. Within the live view, you can adjust the depth by swiping your finger up and down on the screen. It is recommended that you center the bladder in the field of view before you start scanning. Once you find the bladder, you can capture the image by selecting “Capture Image”.
7. Exam Step 2 of 5: On the D1 measurement screen you will have your previously captured transverse image with a measurement line placed. Drag the blue end points such that the lines measures the widest point of the bladder.
8. Exam Step 3 of 5: On the D2 measurement screen, drag the blue end points such that the line measures the deepest point of the bladder. Click “Confirm” when complete.
9. Exam Step 4 of 5: Next, the app will walk you through the longitudinal image capture. On the scan screen you will have a live image. Rotate the probe 90 degrees such that the white Butterfly logo and battery button on the probe are facing the patient’s right side. Within the live view, you can adjust the depth by swiping your finger

up and down on the screen. It is recommended that you center the bladder in the field of view before you start scanning. Once you find the bladder, you can capture the image by selecting "Capture Image".

10. **Exam Step 5 of 5:** On the D3 measurement screen, drag the blue end points such that the line measures the bladder from apex to base. Click "Confirm" when complete.
11. You will be presented with a screen showing the volume. On the left side you will see the volume and diameter measurements. On the right side you will see the transverse and longitudinal images captured. The volume measurement has a barcode associated with it, which you can scan into an EHR system. The type of code can be configured in the settings menu.

**NOTE**

Once you end the scan, the images will be deleted permanently.

## 14.5. Available Settings

To access the settings menu, tap on the top-right corner (the gear symbol ). Under the settings menu, you can access and adjust the following:

1. **My Probe:** Access to information about the probe's serial number, probe's model, etc.
2. **Configure Barcode:** Select the type of the barcode which encodes the volume measurement and can be scanned into an EHR system. From the menu you can Enable or Disable the display of the barcode, as well as select one of the following styles for the barcode:
  - a. Code 128
  - b. Aztec Code
  - c. Data Matrix
  - d. QR Code
3. **Quick start page:** configure if the Quick Start Page is displayed each time or if it is skipped upon start up.
4. **Auto-freeze:** Enable/disable the auto-freeze functionality, if enabled, when the probe detects that it has not been scanning for >30 seconds (e.g. probe scanning in air), it freezes the screen to save the probe's battery.
5. **Manual Calculation:** Enable/Disable the Manual Volume Calculation Package.
6. **Contact Support:** Contact Butterfly Network's support team.
7. **User manual:** Access an e-copy of the user manual.

## 15. Connecting the Power Source using a Mobile Device Charging Kit

The Mobile Device Charging Kit allows the user to simultaneously charge the compatible USB-C Apple iPad device while imaging with the Butterfly iQ+/iQ+ Bladder.



### NOTE

Depending on your platform, hardware, and country, the Mobile Device Charging Kit may not be available.

The Mobile Device Charging Kit is only available on the Butterfly iQ+/iQ+ Bladder.

### 15.1. Connecting the Mobile Device Charging Kit to the Butterfly iQ+/iQ+ Bladder

The following figure shows the Splitter USB-C used as part of the Butterfly iQ+/iQ+ Bladder system and how it is connected to the power supply and to the iPad. The Splitter USB-C gives the user the ability to charge the iPad while imaging. For the correct connection, please connect the devices as shown in the following figure:

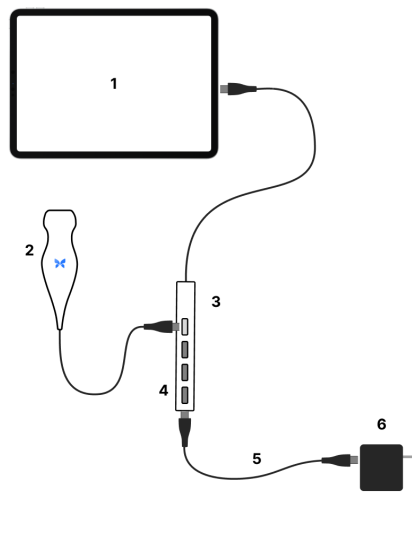

In the figure above, the numbers are referenced as follows:

(1)	USB-C Apple iPad
(2)	iQ+ / iQ+ Bladder Probe
(3)	Splitter USB-C
(4)	Port Blockers
(5)	USB-C to USB-C cable
(6)	Power Adapter



**WARNING!**

When using the Splitter USB-C to power the mobile device, only use the power adapter provided by Butterfly Network, Inc.

The Splitter USB-C contains three port blockers required for electrical safety. Do not remove the port blockers. Any system configuration other than described above is considered improper use and may result in serious personal injury or death.

## 15.2. Mobile Device Charging Kit Components

The following table shows a summary of the mobile device charging kit components found inside the package:

Butterfly Mobile Device Charging Kit components	
<b>Component (Quantity)</b>	Power adapter (1)
	Splitter USB-C (1)
	USB-C to USB-C cable (1)

## 16. Maintenance

This chapter provides information and instructions for storing, transporting, cleaning, and disinfecting the probe.

### 16.1. Maintaining the Probe

#### Receiving and Unboxing the Probe

In the event the packaging of the device is damaged upon receipt of the system, inspect the components as listed in [System Components](#) for any visible damage. Confirm system functionality per [Performing the Probe Diagnostic Test \[84\]](#). If there is any visible damage or if the system is not functioning properly as received, contact the Butterfly Support team using one of the methods listed in [Getting Support \[93\]](#).

#### Storing and Transport:



#### CAUTIONS!

- Avoid storing the probe where the probe or its cable could be easily damaged.
- Avoid transporting the probe unless it is well supported and secured. Avoid swinging the probe or supporting the probe solely from its cable.

The probe should be stored in clean, dry, and moderate temperature conditions.

Follow these steps for daily storage and transport:

- When storing the probe, wrap the cable around the probe so that there is some slack at the bottom of the probe. See [Figure 2, “Wrapping the Cable” \[79\]](#) for reference.
- Avoid placing or storing in areas of excessive hot or cold temperatures or direct sunlight.
- Avoid placing or storing with other equipment or objects that may inadvertently damage the probe, particularly the face.
- Avoid contamination by:
  - Following the cleaning and disinfecting instructions.
  - Making sure the equipment is dry.
  - Carefully handling the probe to prevent damaging the equipment.



#### CAUTIONS!

- Leave some slack in the cable where it connects to the probe so as to reduce pinching or other damage to the cable. As shown in [Figure 2, “Wrapping the Cable” \[79\]](#) [i] Loosely wrap the remaining cable around the probe and [ii] leave 2 inches minimum. Please do not wrap the cable around other objects or in any parts of carrying cases that are not Butterfly approved or recommended.
- Insufficient slack may damage the cable and cause premature failure of the cable wires.

**Figure 2. Wrapping the Cable**

Butterfly iQ+

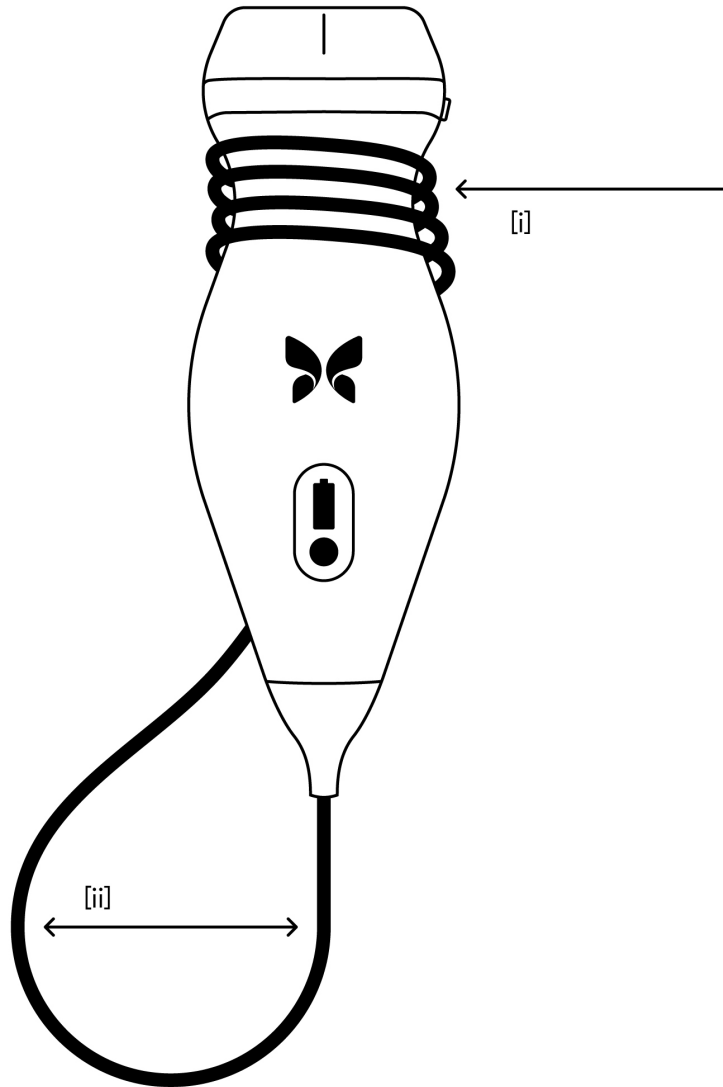

## 16.2. Cleaning and Disinfecting the Probe at the Point-of-Use



**WARNING!**

Failure to disinfect the probe may result in an increased spread of pathogens.



### CAUTION!

Only clean the probe with approved cleaning products and wipes. Improper cleaning or disinfection methods or using non-approved cleaning and disinfecting solutions may damage equipment.

This section provides information and instructions for properly cleaning and disinfecting the Butterfly iQ+ probe. Following these instructions will also help to avoid damaging the probe during cleaning and disinfection. After each exam, promptly clean and disinfect the Butterfly iQ+ per the instructions below to prevent drying of soil and contaminants in and on the device.

While the Cleaning and Disinfection guidance contained here has been validated for effectiveness, a list of cleaning and disinfection products that are compatible with the Butterfly iQ+ probe, but not tested for effectiveness by Butterfly, can be found in the "Compatible Cleaning and Disinfection Products" article available at [support.butterflynetwork.com](http://support.butterflynetwork.com). The products listed in the Compatible Cleaning and Disinfection Products article will not impact the functionality of the probe when used according to the instructions provided by the manufacturer of the product.

## 16.2.1. Cleaning the Probe



### CAUTIONS!

- Prevent any fluid from entering electrical or metal portions of the cable's connector during the cleaning and disinfecting process. Damage due to fluid in these areas may result.
- Prevent any fluid from splashing on your mobile device's touchscreen during scanning and during cleaning. Damage due to fluid may result.

#### To clean the probe:

1. After each use of the probe, use one of the recommended liquid saturated wipes (Super Sani-Cloth® Germicidal Disposable Wipes by PDI, Inc., Super Sani-Cloth® AF3 Disposable Wipes by PDI, Inc., or a lint-free cloth moistened with water) to remove ultrasound transmission gel from the probe.
2. Disconnect the probe from the mobile device.
3. Wipe the probe, strain relief, cable, and connector with one of the recommended liquid saturated wipes for one (1) minute and until visibly clean.
4. Change the wipes as necessary and repeat the above step until the probe is visibly clean.
5. Air dry the probe. Alternatively, use a soft non-linting cloth, blot the lens dry. Do not wipe the lens. Dry the rest of the probe, cable, strain relief, and connector.
6. Visually inspect the probe in a well-lit area to ensure all surfaces are clean. If the probe is not clean, repeat the cleaning steps above.
7. Dispose of cleaning material in accordance with all applicable regulations.

For the most up to date list of approved cleaners please visit [support.butterflynetwork.com](http://support.butterflynetwork.com).



## 16.2.2. Disinfecting the Probe



### WARNING!

Always inspect the probe before and after cleaning, disinfection, or use. Check the lens face, cable, housing, seams, and connector for signs of damage such as cracks, chips, abrasions, or leaks. To avoid the risk of electrical hazards, do not use the probe if there is any sign of damage.

After cleaning the probe, you must disinfect the probe.

To reduce the risk of contamination and infection, it is important to choose the appropriate level of disinfection, based on prior exam usage and whether the use is classified as non-critical or semi-critical. Use [Table 9, “Probe Disinfection Class, Use, and Method” \[81\]](#) to determine the appropriate class and then follow the appropriate intermediate-level or high-level disinfection procedure.

**Table 9. Probe Disinfection Class, Use, and Method**

Class	Use	Method
Non-Critical Class	Touches intact skin	Cleaning followed by intermediate-level disinfection (ILD)
Semi-Critical Class	Touches mucous membranes and non-intact skin	Cleaning followed by high-level disinfection (HLD)

### Intermediate-Level Disinfection (ILD)

It is recommended that you use Super Sani-Cloth® Germicidal Disposable Wipes by PDI, Inc. or bleach (0.6% Sodium Hypochlorite) and clean with non-linting wipes.

#### To disinfect the probe using the Intermediate-Level Disinfection (ILD) method with Super Sani-Cloth® Germicidal Disposable Wipes by PDI, Inc.:

1. Wipe the probe, cable, strain relief, and connector with a Super Sani-Cloth® Germicidal Disposable Wipe. Use additional fresh wipes as needed.
2. Make sure the treated surface remains visibly wet for a minimum of two (2) minutes paying attention to seams, gaps, gasket material, and recessed areas.
3. Use additional fresh wipes as needed to ensure continuous two (2) minutes of contact time.
4. Air dry the probe. Alternatively, use a soft non-linting cloth, blot the lens dry. Do not wipe the lens. Dry the rest of the probe, cable, strain relief, and connector.
5. Once clean and disinfected, visually inspect the probe, strain relief, cable, and connector for signs of damage or wear.

#### To disinfect the probe using the Intermediate-Level Disinfection (ILD) method with bleach (0.6% Sodium Hypochlorite) and clean non-linting wipes:

1. Wipe the probe, cable, strain relief, and connector using a clean non-linting wipe wetted (damp but not dripping) with bleach (0.6%). Use additional fresh wipes as needed.
2. Make sure the treated surface remains visibly wet for a minimum of ten (10) minutes paying attention to seams, gaps, gasket material, and recessed areas.
3. Use additional fresh wipes as needed to ensure continuous ten (10) minutes of contact time.
4. Air dry the probe. Alternatively, use a soft non-linting cloth, blot the lens dry. Do not wipe the lens. Dry the rest of the probe, cable, strain relief, and connector.
5. Once clean and disinfected, visually inspect the probe, strain relief, cable, and connector for signs of damage or wear.

## High Level Disinfection

It is recommended that you use Cidex<sup>®</sup> OPA<sup>10</sup> by Ethicon US, LLC.

### Making sure your probe is compatible with HLD:

1. Enter the Settings menu.
2. Tap **My iQ** to display the **My iQ** screen.
3. Ensure that the **High-Level Disinfection Supported** line indicates **Yes**.
4. Proceed with HLD only if supported on your probe.
5. Disconnect the probe from the mobile device.

### Disinfecting the probe using the High-Level Disinfection (HLD) method:

1. After cleaning the probe, you must disinfect the probe. It is recommended that you use Cidex<sup>®</sup> OPA high-level disinfection solution.
2. Prepare Cidex<sup>®</sup> OPA high-level disinfection solution for use per the manufacturer's instructions. Fill a tray or basin with the disinfectant solution at room temperature (minimum temperature of 20°C) to a level allowing immersion of the probe up to the immersion line (the dashed line shown in [Figure 3, "Probe Immersion Line" \[82\]](#)).
3. Immerse the probe in Cidex<sup>®</sup> OPA solution up to the immersion line and ensure no air or bubbles are trapped. Allow soaking according to the manufacturer's instructions.
4. Thoroughly rinse the probe (up to the immersion line) by immersing it in a large volume of room temperature critical (purified) water for a minimum of one (1) minute. Remove the probe and discard the rinse water. Do not reuse the water. Always use fresh volumes of water for each rinse. Repeat this stage two (2) additional times for a total of three (3) rinses.
5. Thoroughly dry all surfaces of the device using a sterile, lint-free wipe or cloth, changing wipes/cloths when necessary to ensure the device is completely dry. Visually inspect the device to ensure all surfaces are clean and dry. Repeat the drying steps if any moisture is visible.
6. Once clean and disinfected, visually inspect the probe, strain relief, cable, and connector for signs of damage or wear.

### Figure 3. Probe Immersion Line

Butterfly iQ+

---

<sup>10</sup>Cidex<sup>®</sup> OPA is an FDA cleared HLD solution.

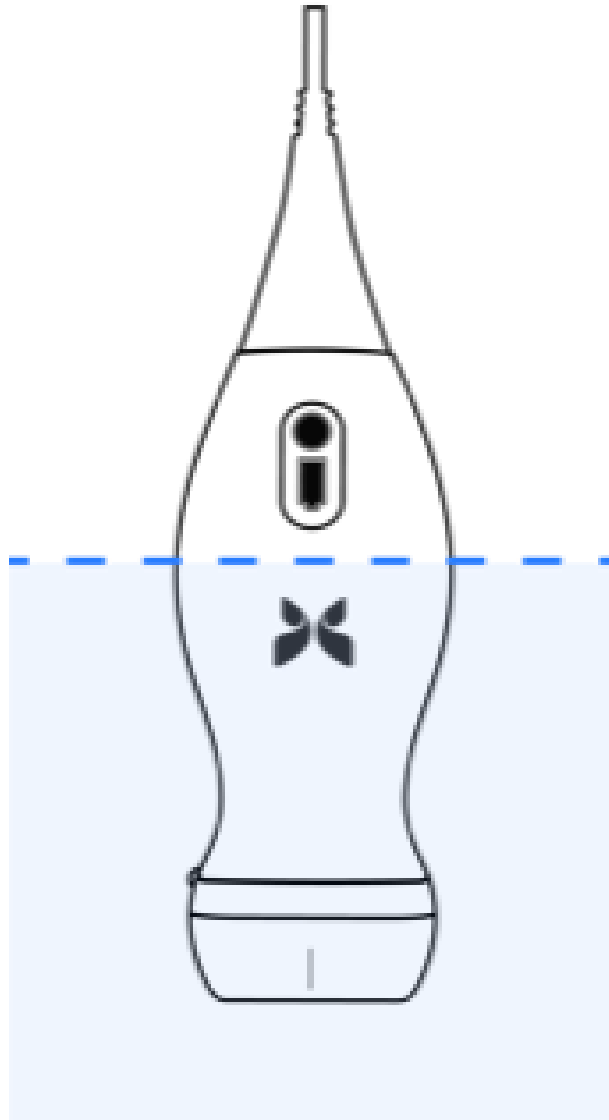

## 16.3. Updating the Probe and App Software

Updates to the Butterfly iQ App and probe are handled through the Apple App Store or Google Play Store.

Keep your mobile device's operating system and the Butterfly iQ App updated to ensure you have the most up-to-date version.



### CAUTION!

Only download the Butterfly mobile application from the Apple app store, the Google Play app store, or via your organization's Mobile Device Management Solution (MDM) (If applicable).



### CAUTION!

When the application is no longer going to be used on the applicable mobile device, please uninstall the application according to the iOS or Android workflow in order to remove any applicable user data from the device.



### NOTE

When use of the application is no longer necessary, navigate away from the Butterfly iQ application to disable use.

## 16.4. Performing the Probe Diagnostic Test

Butterfly iQ+ is capable of performing user-initiated diagnostic self-tests designed to assess the system's readiness for use.

Perform the diagnostic test periodically. With normal use, monthly testing is best practice.

The diagnostic test is only for the Butterfly iQ+ ultrasound probe. The app does not have the ability to assess the mobile device's screen integrity.

The diagnostic test runs through a series of diagnostic tests and notifies you when all tests have been successfully completed.

### To perform the probe diagnostic test:

1. Make sure the probe is connected to a supported mobile device with the Butterfly iQ App installed.
2. Log in to the app using your login credentials.
3. Enter the Settings menu.
4. Tap **My iQ** to display the **My iQ** screen.
5. Tap **Run Diagnostics** and then select **Start Probe Diagnostics** to perform the test.

### Probe Diagnostic Test

The Probe Diagnostic Test performs a test of the digital and acoustic performance of the transducer elements. If the Probe diagnostic test indicates a failure, the user should contact Butterfly Network for further [support \[93\]](#).

Additionally, each time the probe is turned on, and while it is running, the system tests the analog and digital subsystems, safety sensors, battery level, etc. and detects and reports failures should there be any concern.

## 16.5. Replacing the Butterfly iQ+ Cable



### CAUTION!

Refrain from excessively removing and installing a cable, as this will lead to premature wear of the o-ring and enable water and dust ingress.

The cable on the Butterfly iQ+ probe can be replaced in the case of damage or a mobile device with a different connector type needs to be used. The probe and cable compatibility is summarized in [Table 10, “Probe and Replaceable Cable Compatibility” \[85\]](#).

**Table 10. Probe and Replaceable Cable Compatibility**

Probe	Accessory Cables	Model Number	Package SKU Number (if applicable)
Butterfly iQ+ Model Number: 850-20014	Butterfly iQ+ Accessory Cable, Lightning, 1.50M	900-20010-02	This Lightning cable is not available as a replacement. If a replacement is needed refer to the 490-00189-02 Lightning Cable model.
	Butterfly iQ+ Accessory Cable, Lightning, 1.50M	490-00189-02	900-20010-12
	Butterfly iQ+ Accessory Cable, USB-C, 1.50M	490-00187-02	900-20011-12
	Butterfly iQ+ Accessory Cable, Lightning, 2.50M	490-00189-03	900-20010-13
	Butterfly iQ+ Accessory Cable, USB-C, 2.50M	490-00187-03	900-20011-13

**Figure 4. Butterfly iQ+ Cable Components**

Butterfly iQ+ cable

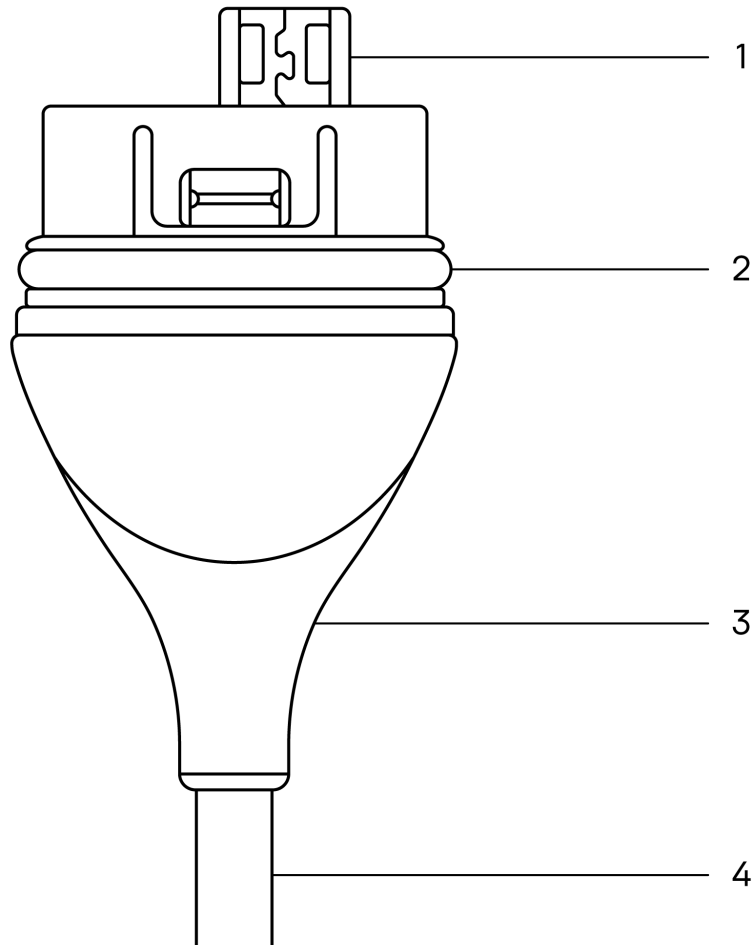

**Table 11. Cable components**

Butterfly iQ+	
1.	USB Plug
2.	O-Ring
3.	Strain Relief
4.	Cord

**Replacing the Butterfly iQ+ Cable**

1. Remove the existing cable from the Butterfly iQ+ probe. Wrap the probe cable around your wrist while holding the probe firmly in the other hand. Pull the two apart. Do not use tools to grab the strain relief or the cord, as doing so might damage the cable.

**Figure 5. Removing the Butterfly iQ+ cable**

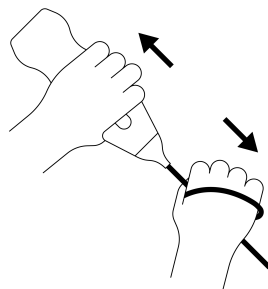

2. Align the connector and the probe, and push the cable firmly into the probe body. When the cable is fully installed, it should be expected that there will be a small gap between the strain relief and the probe body.

**Figure 6. Align the Butterfly iQ+ cable prior to installation**

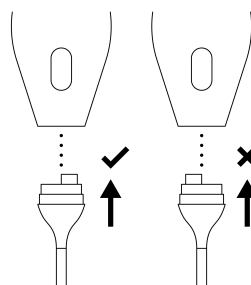

**Figure 7. Expected gap between the cable strain relief and probe body after installing the Butterfly iQ+ cable**

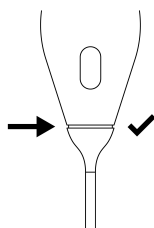

**If planning on submerging the probe to disinfect the probe using HLD:**

1. The Butterfly iQ+ should never be fully submerged in HLD solution. Refer to [High Level Disinfection \[82\]](#) to see the appropriate submersion lines for each probe model.
2. Carefully inspect the O-ring whenever installing a new cable to make sure it is not damaged. See Butterfly iQ+ [Figure 4, "Butterfly iQ+ Cable Components" \[86\]](#) above for an explanation of the location of the o-ring and other cable components.
3. Ensure cable is fully inserted.

## 16.6. Scheduled maintenance

The device initiates an automatic diagnostic test every 25 hours of cumulative scanning. The user can also manually initiate a probe diagnostic test by following the steps in [Performing the Probe Diagnostic Test \[84\]](#). These diagnostic tests are used to monitor the health of the probe. No scheduled maintenance or calibration is required to keep the probe in good working order.

## 16.7. Expected service life for Butterfly iQ+

The expected service life of the Butterfly iQ+ probe is 5 years. The service life of the Butterfly iQ+ ultrasound probe can vary depending on several factors including but not limited to the: usage patterns, usage under environmental conditions, and the user's proper care and maintenance of the device. To achieve the longest service life the user must follow proper usage, storage, and maintenance within the User Manual.

The expected service life of the Butterfly iQ+ cable/charger is 3 years. The service life of the Butterfly iQ+ cable/charger can vary depending on several factors including but not limited to the: usage patterns, usage under environmental conditions, and the user's proper care and maintenance of the accessories. To achieve the longest service life, the user must follow proper usage, storage, and maintenance within the User Manual.



# 17. Troubleshooting

This chapter provides information and instructions for troubleshooting the system.



## WARNING!

Do not use the probe if there is any sign of damage. Contact Support. See [Getting Support \[93\]](#) for more information.

## 17.1. Troubleshooting



## CAUTION!

Ignoring the app alerts and messages may result in the system becoming inoperable.

Table 12, “Troubleshooting” [89] lists the troubleshooting issues and resolutions. See [Getting Support \[93\]](#) for more information.



## NOTES

- If you are unable to resolve an issue, please note the issue and report it to Support for assistance. For more information, see [Getting Support \[93\]](#).
- Call a health care professional for emergency assistance if troubleshooting reveals a patient health problem rather than a mobile device problem.
- To report a complaint or incident, contact the FDA Problem Reporting Program, MedWatch, at 1-800-332-1088, or on the Internet: [www.fda.gov/Safety/MedWatch/](http://www.fda.gov/Safety/MedWatch/).

**Table 12. Troubleshooting**

Issue	Resolution
App will not start	Unplug the probe, delete and reinstall the app.
App crashes	Close the App and restart the app. Check for software updates in the applicable app store.
App opens but will not scan images	Close the App and restart the app. Make sure the probe is charged. If the probe is charged, contact Support.
<b>Imaging Issues</b>	
Image quality degraded	Make sure you are using enough approved ultrasound gel. If quality does not improve, contact Support.
Blank screen or screen no longer updates	Close the App and restart the app. Unplug the probe from the mobile platform (mobile device) and reconnect.
Image degradation or occurrence of image artifacts	Make sure you are using the appropriate preset and the depth is appropriate for the anatomy being scanned. Make sure the brightness on your screen is set to the recommended setting of 65%. To determine if your probe is damaged, activate the probe self-test. For details, see <a href="#">Performing the Probe Diagnostic Test [84]</a>
<b>Study Issues</b>	

Issue	Resolution
Cannot upload a study; study remains in Outbox	Make sure your mobile device has network connectivity (WiFi or a cellular connection). Butterfly Cloud service may be undergoing maintenance or may be unavailable. Try again later.
<b>Probe Issues</b>	
Persistent probe connection error	Perform a hard reset:
Probe will not charge	<ol style="list-style-type: none"> <li>1. Disconnect the probe from the mobile device.</li> <li>2. Press and hold the probe's Battery Indicator Button for 10-15 seconds until LEDs flash.</li> <li>3. Repeat Step 2 and then try reconnecting the probe to the mobile device.</li> <li>4. You may need to charge the probe for at least six (6) hours.</li> </ol>
<b>App Alerts and Messages</b>	
App opens but cannot login: <b>Device Passcode Required</b>	This indicates that your mobile device does not have a passcode. Butterfly iQ requires the mobile device to have a passcode for patient data security. Tap <b>Settings</b> on your device to enable and configure the passcode for your mobile device.
App opens but cannot log in: <b>Login Error</b>	<ul style="list-style-type: none"> <li>• Make sure your mobile device has network connectivity (WiFi or a cellular connection).</li> <li>• Try to re-enter your credentials.</li> <li>• Reset your password using a desktop computer browser to access Butterfly Cloud (<a href="http://cloud.butterflynetwork.com">cloud.butterflynetwork.com</a>)</li> </ul> <p>If the steps above are not successful, it may indicate that Butterfly Cloud service is undergoing maintenance or is unavailable. Try again later.</p>
<b>Hardware Recall</b> alert appears	The probe cannot be used for imaging if this alert is displayed. Tap <b>Contact Support</b> and follow the on-screen instructions.
<b>Forced Log Out</b> alert appears	This indicates that your mobile device does not have a passcode. Butterfly iQ requires the mobile device to have a passcode for patient data security. Tap <b>Settings</b> to enable and configure the passcode for your mobile device.
<b>Probe Temporarily Disabled</b> alert appears	This alert is displayed when your mobile device has not been connected to the Internet within the last 30 days. Reconnect to the Internet and tap <b>Refresh</b> .
<b>Scanning can resume after cooling is complete</b> alert	This alert is displayed when the probe has become too warm for scanning. The system limits patient contact temperature and will not scan at or above 43°C (109°F). The system provides this alert prior to shutting off. Scanning can continue during this message until the probe reaches the auto-cool initiation. Auto-cool is triggered to ensure patient safety. Scanning will resume after the auto-cool has reduced the probe temperature.

## 17.2. Troubleshooting overheating issues with the probe

Unlike traditional ultrasound with piezoelectric crystals, the Butterfly probe uses ultrasound on a chip as well as a battery within the probe.

It is expected for the probe to generate heat during scanning and charging. Some presets use more power than others and you may experience a temperature increase over a shorter duration.

### Factors that can affect the heat of the probe are:

- Ambient environment.
- Probe temperature at the start of scanning
- Duration of uninterrupted scan time
- Duration of resting periods between scans
- Preset and mode selected
- Auto-cool initiation feature

### Probe Temperature Alert

An alert is displayed on the bottom of the screen when the estimated probe temperature reaches 41.5°C, as it is approaching the point where it is too warm for scanning.

You can continue scanning during this warning message until the probe reaches the auto-cool initiation.

Auto-cool initiation is triggered when the contact temperature reaches 43°C. The Butterfly app will continue to be accessible while the auto-cool feature is in progress. The in progress study collateral (images and cines) will not be impacted.

Scanning can resume after the auto-cool feature has reduced the estimated probe temperature to 38.5°C.

Expected uninterrupted scan time in a high-power preset depends on your probe model, it is approximately 10-25 minutes when you start scanning with the probe at ambient temperature (~25°C). On the Butterfly iQ+, if you remove the probe from the charging pad before or immediately after charging is complete, it is recommended that the probe be allowed time to cool before use.

Starting a scanning session with a cool probe will optimize scan time performance.

### Probe Temperature During Charging

It is normal that the probe may feel warm to the touch while charging, especially on the Butterfly iQ+, which uses wireless charging that is known to create heat during the charging process. On the Butterfly iQ+, if you feel the probe is overheating during charging, review best practices for probe orientation based on the charger model, as positioning the probe on the charging pad incorrectly can increase the temperature of the probe while charging.

## 17.3. Troubleshooting Charging Issues

Sometimes if the probe is left idle for a long period of time, the battery can become fully depleted and the probe will not charge. Often, it can be reactivated by completing the following steps.

### Butterfly iQ+ Troubleshooting

1. First, verify that your charger is working. The Butterfly charger should charge any mobile device that charges wirelessly. For more information about charger behavior, and the correct orientation of the probe on the charging pad, please refer to [Probe Battery Charger \[24\]](#).
  - Plug the butterfly charger directly into the wall using only the provided Butterfly equipment. Do not use an outlet tied to a dimmer switch. Do not use a surge protector. Do not use a power strip.
  - Only use an approved Butterfly charging pad.
2. After you verify that the charger is working, place your Butterfly on the charger for five minutes.
3. While your Butterfly probe is on the charger, reset it. To do so, hold down the battery indicator button for 10-15 seconds.
4. Leave your Butterfly probe on its charger overnight, or at least 6 hours.
5. Reset the Butterfly probe again while it is on the charger by holding down the battery indicator button for 10-15 seconds. The LEDs on the battery indicator button should flash.
6. Reconnect the Butterfly probe to your mobile device.

*If these instructions do not resolve your issue, please follow the in-app probe troubleshooting steps as follows:*

1. Log in to the Butterfly iQ app and navigate to the scan screen.
2. Connect the probe and wait for at least 5 seconds.
3. A message will appear ("Plugged in, but not connecting?"). Tap "Run troubleshooting" to continue.
4. Follow the troubleshooting steps on the screen.
5. If you continue to have charging issues, Contact Butterfly Support at <http://support.butterflynetwork.com/>, and provide the following information:
  - Serial number on the back of your probe.
  - Answers to the following questions:
    - What color appears on the charging base while the probe is resting on it?

- What is the pattern or sequence of lights when the probe is first placed on a charge?
- And what is the pattern when it is taking a charge?
- For reporting purposes, please state whether any patient or user injury, clinically significant delay in treatment or diagnosis, misdiagnosis or adverse event occurred as a result of this issue.

## 18. Getting Support

This chapter lists contact information if you require support for the probe and Butterfly iQ App.

### 18.1. Contacting Butterfly Support

Butterfly Network, Inc.

1600 District Ave

Burlington, MA 01803 USA

**Telephone:** +1 (855) 296-6188

**General inquiries:** [info@butterflynetwork.com](mailto:info@butterflynetwork.com)

**Support and service:** [support.butterflynetwork.com](http://support.butterflynetwork.com)

**Website:** [www.butterflynetwork.com](http://www.butterflynetwork.com)



#### Authorized European Representative

Emergo Europe B.V.

Westervoortsedijk 60

6827 AT Arnhem

The Netherlands

#### Australian Sponsor

Emergo Australia

Level 20, Tower II

Darling Park

201 Sussex Street

Sydney, NSW 2000

Australia



#### Authorized Swiss Representative

MedEnvoy Switzerland

Gotthardstrasse 28

6302 Zug

Switzerland

### 18.2. Contacting Support through the Butterfly iQ App

You can contact Butterfly Support directly through the Butterfly iQ App and submit a request for help.

#### To access support:

1. From the imaging screen, tap the down arrow in the upper left corner.
2. Tap on your avatar on the bottom right tab.
3. Scroll down to **Contact Support** to send messages directly to our customer support team.

## 19. Specifications

This chapter lists the technical specifications for the probe and Butterfly iQ software application. It also includes regulatory information as well as instructions for recycling and disposal of equipment.

### 19.1. Mobile Device Requirements



#### WARNING!

Do not use the Butterfly iQ App on a mobile device that does not meet minimum requirements. Using the Butterfly iQ App on a mobile device that does not meet the minimum requirements may affect performance and image quality, possibly resulting in misdiagnosis.

Butterfly iQ+ works on many Apple and Android devices. For the latest list of compatible mobile devices please visit [support.butterflynetwork.com](http://support.butterflynetwork.com).



#### NOTE

The Butterfly iQ App does not affect the mobile device's operating system settings.

### 19.2. System Specifications

**Table 13. System Specifications**

Item	Butterfly iQ+
Probe dimensions	163 x 56 x 35 mm (6.4 x 2.2 x 1.4 in.)
Probe weight	309 grams (.68 lbs)
Power	Battery (rechargeable)
Battery Life	2 hours in B-Mode (typical new battery at 25°C). 2 hours refers to continuous scanning vs. traditional scanning patterns.
Languages	The user interface and accompanying documentation is localized in English, Spanish, French, German, Italian, Polish, Portuguese, Dutch, Danish, Norwegian, Swedish, and Finnish.
Display	Variable
Min/Max scan depth	1 cm min / 30 cm max <sup>a</sup> .
Ultrasound chip	Integrated CMOS chip
Transducers	~9000-element CMUT
Frequency Range	1-10 MHz <sup>b</sup> .
Operating system	<ul style="list-style-type: none"> <li>• Apple devices require iOS 16.0 or newer. Not compatible with beta or unreleased versions.</li> <li>• Google Pixel, OnePlus, and Samsung mobile devices require Android version 10 or newer. Not compatible with beta or unreleased versions.</li> </ul>

<sup>a</sup>Butterfly iQ+ Bladder only utilizes the Bladder preset, as such the depth is limited between 5 cm and 20 cm

<sup>b</sup>Butterfly iQ+ Bladder only utilizes the Bladder preset, as such the available frequency range is 1-5 MHz

### 19.3. Probe Battery Charger

**Table 14. Butterfly iQ+ Battery Charger Specifications**

<b>Probe Charging Pad</b>				
	Item	Specification		
	Wireless Charging Standard	Qi Compliant		
	Input Voltage	DC 5V / 2A		
Input Interface	Micro-USB			
Wireless Charging Power	10W	10W	5W	
Wireless Charging Efficiency	> 73%			
Protection	Over voltage protection, Over current protection			
Dimensions	121 x 62 x 11mm	121 x 62 x 19mm	121 x 62 x 19mm	
Color	Black/Blue	Black	Black	

### 19.4. Environmental Operating Conditions

Table 15, “Environmental Operating Conditions” [95] lists the environmental conditions for the Butterfly iQ+ probe only. For details on the mobile device on which you run the Butterfly iQ App, refer to the accompanying documentation for your mobile device.

**Table 15. Environmental Operating Conditions**

Item	Operating Limits
	Butterfly iQ+
Relative Humidity	Between 18-93% non-condensing
Altitude	Between 46 m (150 ft) below sea level and 3048 m (10,000 ft) above sea level
Operating Temperature	Between 5°C to 39°C
Brief Storage Temperature	The probe can withstand three days of storage at temperatures between -20°C and 50°C

Given the device is handheld, it is expected that the device will be subject to various conditions and environments, including those present in the hospital, EMS, and home. While the device was designed to operate safely in wide range of environments and in varying conditions, care should still be taken to protect the device from extreme

temperatures, shock, drop, and other extreme conditions. See [Table 16, “Environment Compliance” \[96\]](#) for a summary of environmental compliance.

**Table 16. Environment Compliance**

Environment Compliance	Butterfly iQ+
IEC 60601-1-11, Home Use	✓
IEC 60601-1-12, EMS Environment	✓

## 19.5. Electromagnetic Conformance (EMC)

The Butterfly iQ+ is intended to enable diagnostic ultrasound imaging and measurement of anatomical structures and fluids by qualified and trained healthcare professionals. Electromagnetic fields, however, can cause distortion or degradation of this information, affecting this performance.

The Butterfly iQ+ has been designed for use within electromagnetic environments specified in [Table 17, “Electromagnetic Emissions” \[96\]](#) and [Table 18, “Electromagnetic Immunity” \[97\]](#). To avoid radiated and conducted electromagnetic disturbances, the customer or the user of the Butterfly iQ+ should assure that it is used within these stated specifications.

**Table 17. Electromagnetic Emissions**

Guidance and Manufacturer’s Declaration - Electromagnetic Emissions	
Emission Test	Compliance
	Butterfly iQ+
RF emission CISPR 11 EN55011	Group 1 <sup>a</sup> .
RF emission CISPR 11 EN55011	Class B <sup>b</sup> .
Harmonic emission EN/IEC 61000-3-2	Not applicable
Voltage fluctuations/flicker emissions EN/IEC 6100-3-3	Not applicable

<sup>a</sup>The Butterfly iQ+ Ultrasound System uses RF energy only for its internal function. Therefore, its RF emissions are very low and are not likely to cause any interference in nearby electronic equipment.

<sup>b</sup>The Butterfly iQ+ Ultrasound System is suitable for use in all establishments, including domestic establishments and those directly connected to the public low-voltage power supply network that supplies buildings used for domestic purposes.



**Table 18. Electromagnetic Immunity**

Immunity Test	EN/IEC 60601 Test Level	Compliance Level		Electromagnetic Environment - Guidance
	Butterfly iQ+	Butterfly iQ+		
Electrostatic discharge (ESD) EN/IEC 61000-4 -2	±8 kV contact ±2 kV, ±4 kV, ±8 kV, ±15 kV air	±8 kV contact ±2 kV, ±4 kV, ±8 kV, ±15 kV air		Floors should be wood, concrete or ceramic tile. If floors are covered with synthetic material, the relative humidity should be at least 30%.
Electrical transients / bursts EN/IEC 61000-4-4	Not applicable. This device does not function on AC power.	Not applicable.		Mains power quality should be that of a typical commercial or hospital environment.
Power frequency (50/60 Hz) magnetic field IEC 61000-4-8	30 A/m@50Hz or 60Hz 3 orthogonal orientations	30 A/m 50 and 60Hz		Power frequency magnetic fields should be at levels characteristic of a typical location in a typical commercial or hospital environment.
Conducted RF EN/IEC 61000-4-6	3 V 0,15 MHz– 80 MHz 6 V in ISM bands between 150 kHz and 80 MHz 80% AM at 1 kHz	3 V 0,15 MHz– 80 MHz 6 V in ISM bands between 150 kHz and 80 MHz 80% AM at 1 kHz		Portable and mobile RF communications equipment should be used no closer to any part of the Butterfly iQ+ Ultrasound System, including cables, than the recommended separation distance calculated from the equation applicable to the frequency of the transmitter.
Radiated RF IEC 61000-4-3	10 V/m 80 MHz to 6 GHz	10 V/m 80 MHz to 6 GHz		Equations and key recommended separation distances are shown in <a href="#">Separation Distances [97]</a> . Field strengths from fixed RF transmitters, as determined by an electromagnetic site survey, <sup>a</sup> should be less than the compliance level in each frequency range. <sup>b</sup>
Voltage Dips Voltage Interruptions EN/IEC 61000-4-11:2004	N/A	N/A		The EUT was setup according to the test plan and connected to a dropout/variation simulator and the software was set to perform Voltage Dips, Variations and Interruptions Immunity Test.
Proximity Magnetic Fields Immunity IEC 61000-4-39:2017	N/A	N/A		The EUT was placed on a non-conductive table. The radiating coil is placed parallel at a distance of 50 mm from the EUT surface. The EUT performance was monitored for a period of 10 seconds. This procedure was repeated for each spot on the EUT that are subject to illumination by magnetic fields under normal use.

<sup>a</sup>Field strengths from fixed transmitters, such as base stations for radio (cellular/cordless) telephones and land mobile radios, amateur radio, AM and FM radio broadcast and TV broadcast cannot be predicted theoretically with accuracy. To assess the electromagnetic environment due to fixed RF transmitters, an electromagnetic site survey should be considered. If the measured field strength in the location in which the Butterfly iQ+ Ultrasound System is used exceeds the applicable RF compliance level above, the Butterfly iQ+ Ultrasound System should be observed to verify normal operation. If abnormal performance is observed, additional measures may be necessary, such as re-orienting or relocating the Butterfly iQ+ Ultrasound System.

<sup>b</sup>Over the frequency range 150 kHz to 80 MHz, field strengths should be less than 3 V/m.

### 19.5.1. Separation Distances

Devices such as cellular/mobile phones, radio transmitters, and transceivers transmit radio waves (RF), which can create disturbances. The Butterfly iQ+ is intended for use in an electromagnetic environment in which radiated RF disturbances are controlled.

If radiated and conducted electromagnetic disturbances are observed and performance is affected, the user or customer should take measures to mitigate, including relocation or reorientation of the system.

**Table 19. Recommended Separation Distances**

Recommended separation distances between portable and mobile RF communications equipment and the ultrasound unit
The ultrasound unit is intended for use in an electromagnetic environment in which radiated RF disturbances are controlled. The customer or the user of the ultrasound unit can help prevent electromagnetic interference by maintaining a minimum distance between portable and mobile RF communications equipment (transmitters) and the ultrasound unit as recommended below, according to the maximum output power of the communications equipment.

Rated maximum output of transmitter (P, in watts)	Separation distance according to frequency of transmitter (d in meters)		
	150 kHz to 80 MHz $d = 1.2\sqrt{P}$	80 MHz to 800 MHz $d = 1.2\sqrt{P}$	800 MHz to 2.5 GHz $d = 2.3\sqrt{P}$
0.01	0.12	0.12	0.23
0.1	0.38	0.38	0.73
1	1.2	1.2	2.3
10	3.8	3.8	7.3
100	12	12	23

For transmitters rated at a maximum output power not listed above the recommended separation distance d in meters (m) can be estimated using the equation applicable to the frequency of the transmitter, where P is the maximum output power rating of the transmitter in watts (W) according to the transmitter's manufacturer. NOTE 1: At 80 MHz and 800 MHz, the separation distance for the higher frequency range applies. NOTE 2: These guidelines may not apply in all situations. Electromagnetic propagation is affected by absorption and reflection from structures, objects and people.

## 19.6. Acoustic Output

### Ultrasound Safety

Trained professionals should perform diagnostic ultrasound procedures safely for the intended purpose. Butterfly iQ+ Thermal Index (TI) and Mechanical Index (MI) acoustic safety limits are set to industry standards, and as a Track 3 device, are displayed on the display screen. The TI is displayed as either soft tissue (TIS) or bone (TIB), and only one of these indices is displayed at any given time, based on the clinical user setting of a selected exam. TI and MI are displayed in increments of 0.01 over the range of 0.0 to maximum output.

Thermal Index (TI) is the estimate of the temperature increase of soft tissue or bone and its limits are set, based on:

- NEMA Standard, UD 3: "Standard for Real-Time Display of Thermal and Mechanical Acoustic Output Indices on Diagnostic Ultrasound Equipment", Revision 2  
IEC 60601-2-37. Medical electrical equipment. Part 2-37: Particular requirements for the safety of ultrasonic medical diagnostic and monitoring equipment
- IEC 62359:2.0/AMD1:2017, Edition 2.0 Ultrasonics -- Field Characterization: Test methods for the determination of thermal and mechanical indices related to medical diagnostic ultrasound fields

Mechanical Index is the estimated likelihood of tissue damage due to cavitation and its limits (1.9) as set by FDA Guidance, "Information for Manufacturers Seeking Marketing Clearance of Diagnostic Ultrasound Systems and Transducers."

$I_{spta}$  is the Spatial Peak Temporal Average Intensity and the maximum limit of  $I_{spta}$  is 720 mW/cm<sup>2</sup>, which is also set by FDA Guidance, "Information for Manufacturers Seeking Marketing Clearance of Diagnostic Ultrasound Systems and Transducers."

Although these acoustic output settings have been limited in compliance with these standards, it is incumbent on the user to be trained in the use of the ultrasound and aware of the potential for ultrasound-induced bioeffects and to minimize patient exposure to potential harmful effects and unnecessary risk. Ultrasound users should be knowledgeable in ultrasound procedures and be able to perform them at output levels and exposure times that are As Low As Reasonably Achievable (ALARA). ALARA is defined as ultrasound exposure kept as low as reasonably achievable while optimizing diagnostic information.

An example of the ALARA principle is during obstetric ultrasound. Minimizing, for example, the use of Color Doppler, limiting dwell time, scanning only critical structures required for the study, and avoiding studies for non medical reasons are all manifestations of a reduction in exposure to ultrasonic energy.

### Output display uncertainty

MI and TI output display accuracy is dependent on the precision of the measurement system, engineering assumptions within the acoustic model used to calculate the parameters, and variability in the acoustic output of probes. Butterfly compares both internal and 3rd party acoustic and confirms that both measurements are within

recommended display quantization of 0.2 as outlined by the standards. Note that all MI and TI values displayed on the device will not exceed the maximum global values (listed in the tables below) by more than 0.2.

**Track 3 Specific Information**

The Butterfly iQ+ adheres to conformance with FDA Track 3 output settings, output display and ALARA safety principles. In support of Track 3 acoustic output, the following tables provide the global maximum acoustic output indices for the probe and each of its clinical output modes.

**Table 20. Diagnostic Ultrasound Indications for Butterfly iQ+**

Transducer: Butterfly iQ+ Ultrasound System transducer								
Intended Use: Diagnostic ultrasound imaging or fluid flow analysis of the human body as follows:								
Clinical Application		Mode of Operation						
General (Track 1 Only)	Specific (Tracks 1 & 3)	B	M	Power	PWD	Color Doppler	Combined (Specify)	
Ophthalmic	Ophthalmic	X		X		X	B-Mode + Color Doppler B-Mode + Power Doppler	
Fetal Imaging & Other	Fetal/Obstetric	X	X	X	X	X	B-Mode + M-Mode B-Mode + Color Doppler B-Mode + Power Doppler	
	Abdominal	X	X	X	X	X	B-Mode + M-Mode B-Mode + Color Doppler B-Mode + Power Doppler	
	Lung	X	X				B-Mode + M-Mode	
	Intraoperative (Specify)							
	Intra-operative (Neuro)							
	Laparoscopic							
	Pediatric	X	X	X			X	B-Mode + M-Mode B-Mode + Color Doppler B-Mode + Power Doppler
	Small Organ (including scrotum, thyroid, breast)	X	X	X			X	B-Mode + M-Mode B-Mode + Color Doppler B-Mode + Power Doppler
	Neonatal Cephalic							
	Adult Cephalic							
	Trans-rectal							
	Trans-vaginal							
	Trans-urethral							
	Trans-esoph. (non-Card.)							
	Musculoskeletal (Superficial)	X	X	X			X	B-Mode + M-mode B-Mode + Color Doppler B-Mode + Power Doppler
	Intravascular							
	Other (Musculoskeletal Conventional)	X	X	X			X	B-Mode + M-Mode B-Mode + Color Doppler B-Mode + Power Doppler

Transducer: Butterfly iQ+ Ultrasound System transducer							
Intended Use: Diagnostic ultrasound imaging or fluid flow analysis of the human body as follows:							
Clinical Application		Mode of Operation					
General (Track 1 Only)	Specific (Tracks 1 & 3)	B	M	Power	PWD	Color Doppler	Combined (Specify)
	Other (Gynecological)	X	X	X		X	B-Mode + M-Mode B-Mode + Color Doppler B-Mode + Power Doppler
	Other (Urology)	X	X	X		X	B-Mode + M-Mode B-Mode + Color Doppler B-Mode + Power Doppler
Cardiac	Cardiac Adult	X	X			X	B-Mode + M-Mode B-Mode + Color Doppler
	Cardiac Pediatric	X	X			X	B-Mode + M-Mode B-Mode + Color Doppler
	Intravascular (Cardiac)						
	Trans-esoph. (Cardiac)						
	Intra-cardiac						
Peripheral Vessel	Peripheral vessel	X	X	X		X	B-Mode + M-Mode B-Mode + Color Doppler B-Mode + Power Doppler
	Other (Carotid, deep vein thrombosis, arterial studies)	X	X	X		X	B-Mode + M-Mode B-Mode + Color Doppler B-Mode + Power Doppler
	Other (Procedural Guidance)	X	X	X	X	X	B-Mode + M-Mode B-Mode + Color Doppler B-Mode + Power Doppler

### 19.6.1. Acoustic Output Limits

The ultrasound system maintains acoustic outputs below the appropriate limits for each application listed below.

#### Non ophthalmic applications:

System Probe	I <sub>SPTA.3</sub>	TI Type	TI Value	MI	I <sub>PA.3</sub> @MI <sub>max</sub>
Butterfly iQ+	146.47 mW/cm <sup>2</sup>	TIB	0.85	0.51	102 W/cm <sup>2</sup>

#### Ophthalmic applications:

System Probe	I <sub>SPTA.3</sub>	TI Type	TI Value	MI	I <sub>PA.3</sub> @MI <sub>max</sub>
Butterfly iQ+	8.12 mW/cm <sup>2</sup>	TIB	0.047	0.162	6.48 W/cm <sup>2</sup>

For additional information please visit [support.butterflynetwork.com](http://support.butterflynetwork.com).

### 19.6.2. Acoustic Output Tables



#### NOTE

For complete definitions of the measurements used in [Acoustic Output Tables \[100\]](#) please reference Table 201.101 in IEC 60601-2-37.

**Butterfly iQ+ Acoustic tables**

**Table 21. Butterfly iQ+ B-Mode, Biplane, 3D/Peak MI**

Index Label			MI	TIS		TIB		TIC
				At Surface	Below Surface	At Surface	Below Surface	
Maximum Index Value			0.43	0.00388		0.00388		0.0131
Index Component Value				0.00388	0.00388	0.00388	0.00388	
Assoc Acoustic Parameter	$p_{r,a}$ at $Z_{MI}$	(MPa)	0.76					
	P	(mW)		0.38		0.38		0.38
	$P_{1x1}$	(mW)		0.26		0.26		
	$z_s$	(cm)			2.77			
	$z_b$	(cm)					2.73	
	$Z_{MI}$	(cm)	2.77					
	$Z_{pii,a}$	(cm)	2.77					
	$f_{awf}$	(MHz)	3.12	3.12		3.12		3.12
Other Information	pr	(Hz)	962.8					
	srr	(Hz)	21.4					
	$n_{pps}$		1					
	$I_{pa,a}$ at $Z_{pii,a}$	(W/cm <sup>2</sup> )	21.75					
	$I_{spta,a}$ at $Z_{pii,a}$ or $Z_{sii,a}$	(mW/cm <sup>2</sup> )	0.71					
	$I_{spta}$ at $Z_{pii}$ or $Z_{sii}$	(mW/cm <sup>2</sup> )	1.28					
	$p_r$ at $Z_{pii}$	(MPa)	1.02					
Operating Control Conditions	Preset: Lung							
<b>Note 1:</b>	Only one operating condition per index.							
<b>Note 2:</b>	Data should be entered for "at surface" and "below surface" both in the columns related to TIS and TIB.							
<b>Note 3:</b>	Information on MI and TI need not be provided regarded using TIC for an TRANSDUCER ASSEMBLY not intended for transcranial or neonatal cephalic uses.							
<b>Note 4:</b>	If the requirements of 201.12.4.2a are met, it is not required to enter any data in the columns related to TIS, TIB or TIC							
<b>Note 5:</b>	If the requirements of 201.12.4.2b are met, it is not required to enter any data in the columns related to MI.							
<b>Note 6:</b>	Unshaded cells should have a numerical value. The equipment setting related to the index has to be entered in the operating control section.							
<b>Note 7:</b>	The Depths $Z_{pii}$ and $Z_{pii,a}$ apply to NON-SCANNING MODES, while the depths $Z_{sii}$ and $Z_{sii,a}$ apply to SCANNING MODES.							

**Table 22. Butterfly iQ+ B-Mode, Biplane, 3D/Peak TIS,TIB**

Index Label			MI	TIS		TIB		TIC
				At Surface	Below Surface	At Surface	Below Surface	
Maximum Index Value			0.22	0.0153		0.0153		0.0521
Index Component Value				0.0153	0.0153	0.0153	0.0153	
Assoc Acoustic Parameter	$p_{r,a}$ at $Z_{MI}$	(MPa)	0.41					
	P	(mW)		1.53		1.53		1.53
	$P_{1x1}$	(mW)		0.91		0.91		
	$Z_s$	(cm)			3.60			
	$Z_b$	(cm)					3.57	
	$Z_{MI}$	(cm)	3.60					
	$Z_{pii,a}$	(cm)	3.60					
	$f_{awf}$	(MHz)	3.55	3.55		3.55		3.55
Other Information	pr	(Hz)	2000.0					
	srr	(Hz)	64.5					
	$n_{pps}$		1					
	$I_{pa,a}$ at $Z_{pii,a}$	(W/cm <sup>2</sup> )	6.27					
	$I_{spta,a}$ at $Z_{pii,a}$ or $Z_{sii,a}$	(mW/cm <sup>2</sup> )	1.59					
	$I_{spta}$ at $Z_{pii}$ or $Z_{sii}$	(mW/cm <sup>2</sup> )	3.84					
	$p_r$ at $Z_{pii}$	(MPa)	0.63					
Operating Control Conditions	Preset: Pediatric Cardiology							
<b>Note 1:</b>	Only one operating condition per index.							
<b>Note 2:</b>	Data should be entered for "at surface" and "below surface" both in the columns related to TIS and TIB.							
<b>Note 3:</b>	Information on MI and TI need not be provided regarded using TIC for an TRANSDUCER ASSEMBLY not intended for transcranial or neonatal cephalic uses.							
<b>Note 4:</b>	If the requirements of 201.12.4.2a are met, it is not required to enter any data in the columns related to TIS, TIB or TIC							
<b>Note 5:</b>	If the requirements of 201.12.4.2b are met, it is not required to enter any data in the columns related to MI.							
<b>Note 6:</b>	Unshaded cells should have a numerical value. The equipment setting related to the index has to be entered in the operating control section.							
<b>Note 7:</b>	The Depths $Z_{pi}$ and $Z_{pii,a}$ apply to NON-SCANNING MODES, while the depths $Z_{si}$ and $Z_{sii,a}$ apply to SCANNING MODES.							

**Table 23. Butterfly iQ+ Color/Power + B-Mode/Peak MI,TIB**

Index Label			MI	TIS		TIB		TIC
				At Surface	Below Surface	At Surface	Below Surface	
Maximum Index Value			0.29	0.0479		0.17		0.24
Index Component Value				1: 0.00453 2: 0.0453	1: 0.0453 2: 0.0386	1: 0.00453 2: 0.0430	1: 0.00453 2: 0.16	
Assoc Acoustic Parameter	$p_{r,a}$ at $Z_{MI}$	(MPa)	2: 0.49					
	P	(mW)		1: 0.45 2: 6.72		1: 0.45 2: 6.72		1: 0.45 2: 6.72
	$P_{1x1}$	(mW)		1: 0.27 2: 3.08		1: 0.27 2: 3.08		
	$z_s$	(cm)			1: 3.60 2: 4.37			
	$z_b$	(cm)					1: 3.57 2: 3.77	
	$Z_{MI}$	(cm)	2: 4.37					
	$Z_{pii,a}$	(cm)	2: 4.37					
Other Information	$f_{awf}$	(MHz)	2: 2.94	1: 3.55 2: 2.94		1: 3.55 2: 2.94		1: 3.55 2: 2.94
	pr	(Hz)	2: 1386.7					
	srr	(Hz)	N/A					
	$n_{pps}$		2: 1					
	$I_{pa,a}$ at $Z_{pii,a}$	(W/cm <sup>2</sup> )	2: 10.49					
	$I_{spta,a}$ at $Z_{pii,a}$ or $Z_{sii,a}$	(mW/cm <sup>2</sup> )	23.58					
	$I_{spta}$ at $Z_{pii}$ or $Z_{sii}$	(mW/cm <sup>2</sup> )	57.62					
$p_r$ at $Z_{pii}$	(MPa)	2: 0.76						
Operating Control Conditions	Preset: Pediatric Cardiology							
<b>Note 1:</b>	Only one operating condition per index.							
<b>Note 2:</b>	Data should be entered for "at surface" and "below surface" both in the columns related to TIS and TIB.							
<b>Note 3:</b>	Information on MI and TI need not be provided regarded using TIC for an TRANSDUCER ASSEMBLY not intended for transcranial or neonatal cephalic uses.							
<b>Note 4:</b>	If the requirements of 201.12.4.2a are met, it is not required to enter any data in the columns related to TIS, TIB or TIC							
<b>Note 5:</b>	If the requirements of 201.12.4.2b are met, it is not required to enter any data in the columns related to MI.							
<b>Note 6:</b>	Unshaded cells should have a numerical value. The equipment setting related to the index has to be entered in the operating control section.							
<b>Note 7:</b>	The Depths $z_{pii}$ and $z_{pii,a}$ apply to NON-SCANNING MODES, while the depths $z_{sii}$ and $z_{sii,a}$ apply to SCANNING MODES.							
<b>Note 8:</b>	Component "1:" refers to B-Mode, Component "2:" refers to Color Doppler.							

**Table 24. Butterfly iQ+ Color/Power + B-Mode/Peak TIS**

Index Label			MI	TIS		TIB		TIC
				At Surface	Below Surface	At Surface	Below Surface	
Maximum Index Value			0.17	.0649		0.15		0.42
Index Component Value				1: 0.00323 2: 0.0512	1: 0.00323 2: 0.0617	1: 0.00323 2: 0.0512	1: 0.00323 2: 0.15	
Assoc Acoustic Parameter	$P_{r,a}$ at $Z_{MI}$	(MPa)	2: 0.27					
	P	(mW)		1: 0.59 2: 11.66		1: 0.59 2: 11.66		1: 0.59 2: 11.66
	$P_{1x1}$	(mW)		1: 0.24 2: 4.30		1: 0.24 2: 4.30		
	$Z_s$	(cm)			1: 5.30 2: 4.67			
	$Z_b$	(cm)					1: 4.90 2: 4.30	
	$Z_{MI}$	(cm)	2: 4.67					
	$Z_{pii,a}$	(cm)	2: 4.67					
	$f_{awf}$	(MHz)	2: 2.50		3.55		3.55	3.55
Other Information	pr	(Hz)	2: 1965.3					
	srr	(Hz)	N/A					
	$n_{pps}$		2: 1					
	$I_{pa,a}$ at $Z_{pii,a}$	(W/cm <sup>2</sup> )	2: 2.88					
	$I_{spta,a}$ at $Z_{pii,a}$ or $Z_{sii,a}$	(mW/cm <sup>2</sup> )	10.28					
	$I_{spta}$ at $Z_{pii}$ or $Z_{sii}$	(mW/cm <sup>2</sup> )	23.23					
	$p_r$ at $Z_{pii}$	(MPa)	2: 0.40					
Operating Control Conditions	Preset: Bladder							
<b>Note 1:</b>	Only one operating condition per index.							
<b>Note 2:</b>	Data should be entered for "at surface" and "below surface" both in the columns related to TIS and TIB.							
<b>Note 3:</b>	Information on MI and TI need not be provided regarded using TIC for an TRANSDUCER ASSEMBLY not intended for transcranial or neonatal cephalic uses.							
<b>Note 4:</b>	If the requirements of 201.12.4.2a are met, it is not required to enter any data in the columns related to TIS, TIB or TIC							
<b>Note 5:</b>	If the requirements of 201.12.4.2b are met, it is not required to enter any data in the columns related to MI.							
<b>Note 6:</b>	Unshaded cells should have a numerical value. The equipment setting related to the index has to be entered in the operating control section.							
<b>Note 7:</b>	The Depths $z_{pii}$ and $z_{pii, a}$ apply to NON-SCANNING MODES, while the depths $z_{sii}$ and $z_{sii, a}$ apply to SCANNING MODES.							
<b>Note 8:</b>	Component "1:" refers to B-Mode, Component "2:" refers to Color Doppler.							



**Table 25. Butterfly iQ+ M-Mode + B-Mode/Peak MI**

Index Label			MI	TIS		TIB		TIC
				At Surface	Below Surface	At Surface	Below Surface	
Maximum Index Value			0.43	0.00283		0.00519		0.00953
Index Component Value				1: 0.00246 2: 0.000369	1: 0.00246 2: 0.000298	1: 0.00246 2: 0.000369	1: 0.00246 2: 0.00273	
Assoc Acoustic Parameter	$p_{r,a}$ at $Z_{MI}$	(MPa)	1: 0.76					
	P	(mW)		1: 0.24 2: .0635		1: 0.24 2: .0365		1: 0.24 2: .0365
	$P_{1x1}$	(mW)		1: 0.17 2: .0249		1: 0.17 2: .0249		
	$z_s$	(cm)			1: 2.77 2: 2.77			
	$z_b$	(cm)					1: 2.73 2: 2.73	
	$Z_{MI}$	(cm)	1: 2.77					
	$Z_{pii,a}$	(cm)	1: 2.77					
	$f_{awf}$	(MHz)	1: 3.12		1: 3.12 2: 3.12		1: 3.12 2: 3.11	1: 3.12 2: 3.12
Other Information	prr	(Hz)	1: 610.3					
	srr	(Hz)	1: 15.3					
	$n_{pps}$		1: 1					
	$I_{pa,a}$ at $Z_{pii,a}$	(W/cm <sup>2</sup> )	1: 27.75					
	$I_{spta}$ at $Z_{pii,a}$ or $Z_{sii,a}$	(mW/cm <sup>2</sup> )	1.39					
	$I_{spta}$ at $Z_{pii}$ or $Z_{sii}$	(mW/cm <sup>2</sup> )	2.53					
	$p_r$ at $Z_{pii}$	(MPa)	1: 1.02					
Operating Control Conditions	Preset: Lung							
<b>Note 1:</b>	Only one operating condition per index.							
<b>Note 2:</b>	Data should be entered for "at surface" and "below surface" both in the columns related to TIS and TIB.							
<b>Note 3:</b>	Information on MI and TI need not be provided regarded using TIC for an TRANSDUCER ASSEMBLY not intended for transcranial or neonatal cephalic uses.							
<b>Note 4:</b>	If the requirements of 201.12.4.2a are met, it is not required to enter any data in the columns related to TIS, TIB or TIC							
<b>Note 5:</b>	If the requirements of 201.12.4.2b are met, it is not required to enter any data in the columns related to MI.							
<b>Note 6:</b>	Unshaded cells should have a numerical value. The equipment setting related to the index has to be entered in the operating control section.							
<b>Note 7:</b>	The Depths $z_{pii}$ and $z_{pii, a}$ apply to NON-SCANNING MODES, while the depths $z_{sii}$ and $z_{sii, a}$ apply to SCANNING MODES.							
<b>Note 8:</b>	Component "1:" refers to B-Mode, Component "2:" refers to M-Mode.							

**Table 26. Butterfly iQ+ M-Mode + B-Mode/Peak TIS,TIB**

Index Label			MI	TIS		TIB		TIC
				At Surface	Below Surface	At Surface	Below Surface	
Maximum Index Value			0.19	0.0107		0.0127		0.0732
Index Component Value				1: 0.00952 2: 0.00113	1: 0.00952 2: 0.00135	1: 0.00952 2: 0.00135	1: 0.00952 2: 0.0318	
Assoc Acoustic Parameter	$p_{r,a}$ at $Z_{MI}$	(MPa)	1: 0.31					
	P	(mW)		1: 1.92 2: 0.23		1: 1.92 2: 0.23		1: 1.92 2: 0.23
	$P_{1x1}$	(mW)		1: 0.79 2: 0.0936		1: 0.79 2: 0.0936		
	$Z_s$	(cm)			1: 5.10 2: 5.10			
	$Z_b$	(cm)					1: 4.53 2: 4.53	
	$Z_{MI}$	(cm)	1: 5.10					
	$Z_{pii,a}$	(cm)	1: 5.10					
	$f_{awf}$	(MHz)	1: 2.58		1: 2.58 2: 2.58		1: 2.58 2: 2.55	1: 2.58 2: 2.58
Other Information	prr	(Hz)	1: 828.4					
	srr	(Hz)	1: 9.9					
	$n_{pps}$		1: 1					
	$I_{pa,a}$ at $Z_{pii,a}$	(W/cm <sup>2</sup> )	1: 3.47					
	$I_{spta,a}$ at $Z_{pii,a}$ or $Z_{sii,a}$	(mW/cm <sup>2</sup> )	0.76					
	$I_{spta}$ at $Z_{pii}$ or $Z_{sii}$	(mW/cm <sup>2</sup> )	1.86					
	$p_r$ at $Z_{pii}$	(MPa)	1: 0.48					
Operating Control Conditions	Preset: Abdomen Deep							
<b>Note 1:</b>	Only one operating condition per index.							
<b>Note 2:</b>	Data should be entered for "at surface" and "below surface" both in the columns related to TIS and TIB.							
<b>Note 3:</b>	Information on MI and TI need not be provided regarded using TIC for an TRANSDUCER ASSEMBLY not intended for transcranial or neonatal cephalic uses.							
<b>Note 4:</b>	If the requirements of 201.12.4.2a are met, it is not required to enter any data in the columns related to TIS, TIB or TIC							
<b>Note 5:</b>	If the requirements of 201.12.4.2b are met, it is not required to enter any data in the columns related to MI.							
<b>Note 6:</b>	Unshaded cells should have a numerical value. The equipment setting related to the index has to be entered in the operating control section.							
<b>Note 7:</b>	The Depths $Z_{pii}$ and $Z_{pii, a}$ apply to NON-SCANNING MODES, while the depths $Z_{sii}$ and $Z_{sii, a}$ apply to SCANNING MODES.							
<b>Note 8:</b>	Component "1:" refers to B-Mode, Component "2:" refers to M-Mode.							

**Table 27. Butterfly iQ+ Pulsed Wave / Peak MI,TIS,TIB**

Index Label			MI	TIS		TIB		TIC
				At Surface	Below Surface	At Surface	Below Surface	
Maximum Index Value			0.34	0.2		1.31		0.88
Index Component Value				0.2	0.18	0.2	1.31	
Assoc Acoustic Parameter	$p_{r,a}$ at $Z_{MI}$	(MPa)	0.45					
	P	(mW)		76.47		76.47		76.47
	$P_{1x1}$	(mW)		23.86		23.86		
	$z_s$	(cm)			10.20			
	$z_b$	(cm)					4.27	
	$z_{MI}$	(cm)	4.27					
	$z_{pii,a}$	(cm)	10.20					
	$f_{awf}$	(MHz)	1.79	1.80		1.79		1.80
Other Information	prr	(Hz)	4.E+03					
	srr	(Hz)	N/A					
	$\eta_{pps}$		1					
	$I_{pa,a}$ at $Z_{pii,a}$	(W/cm <sup>2</sup> )	7.8					
	$I_{spta,a}$ at $Z_{pii,a}$ or $Z_{sij,a}$	(mW/cm <sup>2</sup> )	146.47					
	$I_{spta}$ at $Z_{pii}$ or $Z_{sij}$	(mW/cm <sup>2</sup> )	517.54					
	$p_r$ at $Z_{pii}$	(MPa)	0.68					
Operating Control Conditions	Preset: Cardiac Standard							
<b>Note 1:</b>	Only one operating condition per index.							
<b>Note 2:</b>	Data should be entered for "at surface" and "below surface" both in the columns related to TIS and TIB.							
<b>Note 3:</b>	Information on MI and TI need not be provided regarded using TIC for an TRANSDUCER ASSEMBLY not intended for transcranial or neonatal cephalic uses.							
<b>Note 4:</b>	If the requirements of 201.12.4.2a are met, it is not required to enter any data in the columns related to TIS, TIB or TIC							
<b>Note 5:</b>	If the requirements of 201.12.4.2b are met, it is not required to enter any data in the columns related to MI.							
<b>Note 6:</b>	Unshaded cells should have a numerical value. The equipment setting related to the index has to be entered in the operating control section.							
<b>Note 7:</b>	The Depths $z_{pii}$ and $z_{pii, a}$ apply to NON-SCANNING MODES, while the depths $z_{sij}$ and $z_{sij, a}$ apply to SCANNING MODES.							

## Acoustic Output Tables for Ophthalmic Applications

Table 28. Butterfly iQ+ Ophthalmic B-Mode/Peak MI,TIS,TIB

Index Label			MI	TIS		TIB		TIC
				At Surface	Below Surface	At Surface	Below Surface	
Maximum Index Value			0.0946	0.000779		0.000779		0.00134
Index Component Value				0.000779	0.000779	0.000779	0.000779	
Assoc Acoustic Parameter	$P_{r,a}$ at $Z_{MI}$	(MPa)	0.19					
	P	(mW)		0.0394		0.0394		0.0394
	$P_{1 \times 1}$	(mW)		0.0394		0.0394		
	$Z_s$	(cm)			1.67			
	$Z_b$	(cm)					1.55	
	$Z_{MI}$	(cm)	1.67					
	$Z_{pii,a}$	(cm)	1.67					
	$f_{awf}$	(MHz)	4.29	4.29		4.29		4.29
Other Information	prf	(Hz)	3750.0					
	srf	(Hz)	12.5					
	$n_{pps}$		3					
	$I_{pa,a}$ at $Z_{pii,a}$	(W/cm <sup>2</sup> )	2.17					
	$I_{spta,a}$ at $Z_{pii,a}$ or $Z_{sii,a}$	(mW/cm <sup>2</sup> )	0.0880					
	$I_{spta}$ at $Z_{pii}$ or $Z_{sii}$	(mW/cm <sup>2</sup> )	0.14					
	$p_r$ at $Z_{pii}$	(MPa)	0.25					
Operating Control Conditions	Preset: Ophthalmic							
<b>Note 1:</b>	Only one operating condition per index.							
<b>Note 2:</b>	Data should be entered for "at surface" and "below surface" both in the columns related to TIS and TIB.							
<b>Note 3:</b>	Information on MI and TI need not be provided regarded using TIC for an TRANSDUCER ASSEMBLY not intended for transcranial or neonatal cephalic uses.							
<b>Note 4:</b>	If the requirements of 201.12.4.2a are met, it is not required to enter any data in the columns related to TIS, TIB or TIC							
<b>Note 5:</b>	If the requirements of 201.12.4.2b are met, it is not required to enter any data in the columns related to MI.							
<b>Note 6:</b>	Unshaded cells should have a numerical value. The equipment setting related to the index has to be entered in the operating control section.							
<b>Note 7:</b>	The Depths $z_{pii}$ and $z_{pii, a}$ apply to NON-SCANNING MODES, while the depths $z_{sii}$ and $z_{sii, a}$ apply to SCANNING MODES.							

**Table 29. Butterfly iQ+ Ophthalmic Color/Power + B-Mode/Peak MI,TIS,TIB**

Index Label			MI	TIS		TIB		TIC
				At Surface	Below Surface	At Surface	Below Surface	
Maximum Index Value			0.10	0.00700		0.0150		0.0106
Index Component Value				1: 0.000720 2: 0.00628	1: 0.000720 2: 0.00349	1: 0.00720 2: 0.00628	1: 0.00720 2: 0.0143	
Assoc Acoustic Parameter	$p_{r,a}$ at $Z_{MI}$	(MPa)	1: 0.21					
	P	(mW)		1: 0.0358 2: 0.28		1: 0.0358 2: 0.28		1: 0.0358 2: 0.28
	$P_{1x1}$	(mW)		1: 0.0358 2: 0.27		1: 0.0358 2: 0.27		
	$Z_s$	(cm)			1: 2.10 2: 1.78			
	$Z_b$	(cm)					1: 1.85 2: 1.50	
	$Z_{MI}$	(cm)	1: 2.10					
	$Z_{pii,a}$	(cm)	1: 2.10					
Other Information	$f_{awf}$	(MHz)	1: 4.32	1: 4.32 2: 4.81		1: 4.32 2: 4.80		1: 4.32 2: 4.81
	pr	(Hz)	1: 1193.1					
	sr	(Hz)	1: 17.3					
	$n_{pps}$		1: 3					
	$I_{pa,a}$ at $Z_{pii,a}$	(W/cm <sup>2</sup> )	1: 2.54					
	$I_{spta,a}$ at $Z_{pii,a}$ or $Z_{sii,a}$	(mW/cm <sup>2</sup> )	3.23					
	$I_{spta}$ at $Z_{pii}$ or $Z_{sii}$	(mW/cm <sup>2</sup> )	5.84					
$p_r$ at $Z_{pii}$	(MPa)	1: 0.28						
Operating Control Conditions	Preset: Ophthalmic							
<b>Note 1:</b>	Only one operating condition per index.							
<b>Note 2:</b>	Data should be entered for "at surface" and "below surface" both in the columns related to TIS and TIB.							
<b>Note 3:</b>	Information on MI and TI need not be provided regarded using TIC for an TRANSDUCER ASSEMBLY not intended for transcranial or neonatal cephalic uses.							
<b>Note 4:</b>	If the requirements of 201.12.4.2a are met, it is not required to enter any data in the columns related to TIS, TIB or TIC							
<b>Note 5:</b>	If the requirements of 201.12.4.2b are met, it is not required to enter any data in the columns related to MI.							
<b>Note 6:</b>	Unshaded cells should have a numerical value. The equipment setting related to the index has to be entered in the operating control section.							
<b>Note 7:</b>	The Depths $Z_{pii}$ and $Z_{pii,a}$ apply to NON-SCANNING MODES, while the depths $Z_{sii}$ and $Z_{sii,a}$ apply to SCANNING MODES.							
<b>Note 8:</b>	Component "1:" refers to B-Mode, Component "2:" refers to Color/Power Doppler.							

## 19.7. Essential Performance

The Butterfly iQ+ has been designed to ensure that acoustic limits are not exceeded in any imaging mode. The Butterfly iQ+ has been designed and certified to comply with:

- IEC 60601-1:2005+AMD1:2012+AMD2:2020 CSV Medical electrical equipment Part 1: General requirements for basic safety and essential performance.
- IEC 60601-2-37:2007 Medical electrical equipment - Part 2-37: Particular requirements for the basic safety and essential performance of ultrasonic medical diagnostic and monitoring equipment.

## 19.8. Measurement Accuracy

The Butterfly iQ+ device has been designed to perform the following clinical measurements:

### M-mode:

- Distance measurements accurate to within  $\pm 3\%$  of the displayed value.
- Time measurements accurate to within  $\pm 3\%$  of the displayed value.
- Fetal heart rate measurements accurate to within  $\pm 3\%$  of the displayed value.

### B-mode:

- Distance measurements (axial) accurate to within  $\pm 3\%$  of the displayed value.
- Distance measurements (lateral) accurate to within  $\pm 5\%$  of the displayed value.
- Distance measurements (diagonal) accurate to within  $\pm 4\%$  of the displayed value.
- Distance measurements (circumference) accurate to within  $\pm 5\%$  of the displayed value.
- Area measurements accurate to within  $\pm 10\%$  of the displayed value.

### Doppler Spectrum:

- Relative flow speed and direction accurate to within  $\pm 20\%$  of the displayed value.

## 19.9. Waste Electrical and Electronic Equipment

The crossed-out wheeled bin symbol on this device indicates that this equipment has been put on the market after 13 August 2005, and is included in the scope of the directive 2002/96/EEC on Waste Electrical and Electronic Equipment (WEEE) and of the national decree(s), which transpose provisions of such directive. At the end of its lifetime, this device cannot be disposed of as unsorted municipal waste and must be collected separately at specifically authorized treatment facilities. For recycling assistance, please contact the manufacturer or authorized disposal company.



## 19.10. Recycling and Disposal

Butterfly Network is deeply invested in the preservation of the natural environment. Equipment may contain materials that pose a risk to the environment if proper disposal procedures are not followed. Recycle the Butterfly iQ+ probe and accessories at the end of their useful life and in accordance with local, state, provincial, and/or national regulations.

Prior to recycling, items should be clean and contaminant free.









## 20. Symbols

This chapter lists and describes the symbols and icons that may be used on the Butterfly iQ+, its accessories, and packaging.















### 20.1. Symbols







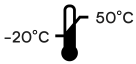

Table 30, “Symbols” [112] lists and describes a set of symbols for medical electronic equipment that classify a connection or warn of potential hazards. The symbols listed in Table 30, “Symbols” [112] may be used on the Butterfly iQ+, and on its accessories and packaging. The symbols shown in this document and on the Butterfly iQ+, and on its accessories and packaging, are compliant with current versions of the listed standards.

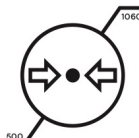



**Table 30. Symbols**

Symbol	Standard	Reference	Title	Description
	ISO 15223-1	5.4.4	Caution	Indicates the need for the user to consult the instructions for use for important cautionary information such as warnings and precautions that cannot, for a variety of reasons, be presented on the medical device itself.
	ISO 7010	W001	Warning	Indicates a general warning.
	ASTM F2503-1	F2503 - 13 3.1.14	MR Unsafe	Indicates an item which poses unacceptable risks to the patient, medical staff, or other persons within the MR environment.
	ISO 15223-1	5.2.8	Do not use if package is damaged	Indicates a medical device that should not be used if the package has been damaged or opened.
	ISO 15223-1	5.1.3	Date of Manufacture	Indicates the date when the medical device was manufactured.
	ISO 15223-1	5.3.1	Fragile; handle with care	Indicates a medical device that can be broken or damaged if not handled carefully.
	-	-	Global Medical Device Nomenclature Code	A system of internationally agreed generic descriptors used to identify all medical device products.
	-	-	Global Trade Item Number	An identifier to look up product information in a database, often by entering the number through a bar code scanner pointed at an actual product.
	IEC 60529	-	Ingress protection rating	Ingress Protection rating system showing the degrees of protection from solid objects and liquids. Butterfly iQ+ is protected against the effects of immersion in water below the cable/probe barrier, as indicated.



Symbol	Standard	Reference	Title	Description
	IEC 60601-1	20	Type BF applied part	Indicates isolated patient connection (Type BF applied part).
	ISO 15223-1	5.3.4	Keep away from rain	Indicates a medical device that needs to be protected from moisture.
	ISO 15223-1	5.1.1	Manufacturer	Indicates the medical device manufacturer, as defined in EU Directives 90/385/EEC, 93/42/EEC and 98/79/EC.
	ISO 15223-1	5.1.11	Country of Manufacture	To identify the country of manufacture of products.
	ISO 15223-1	5.1.5	Batch code	Identifies the manufacturer's batch code so that the batch or lot can be identified.
	-	-	Model name	Model name for the device.
	ISO 15223-1	5.2.7	Non-sterile	Indicates a medical device that has not been subjected to a sterilization process.
	ISO 7010	M002	Refer to instruction manual/ booklet	To signify that the instruction manual/booklet must be read
	ISO 15223-1	5.4.3	Operator's manual; operating instructions	Indicates the need for the user to consult the instructions for use.
	ISO 7000	1135	General symbol for recovery/ recyclable	To indicate that the marked item or its materials is part of a recovery or recycling process.
	ISO 15223-1	5.1.6	Catalogue number	Indicates the manufacturer's catalogue number so that the medical device can be identified.
	ISO 15223-1	5.1.7	Serial number	Indicates the manufacturer's serial number so that a specific medical device can be identified.
	ISO 15223-1	5.3.2	Keep away from sunlight	Indicates a medical device that needs protection from light sources.
	WEEE Directive 2012/19/EU	-	Waste Electrical and Electronic Equipment	Requires a separate collection for electrical and electronic equipment in compliance with the Waste Electrical and Electronic Equipment (WEEE) Directive. When accompanied by Pb or Hg, components of the device may contain lead or mercury, respectively, which must be recycled or disposed of in accordance with local, state, or federal laws. The backlight lamps in an LCD monitor contain mercury.

Symbol	Standard	Reference	Title	Description
	Regulation (EU) 2017/745	-	European Conformity	The Butterfly iQ+ meets the requirements of the European Union Medical Device Regulation (EU MDR).
	-	-	USA & Canadian Certification	TÜV Rheinland of North America is accredited as a Nationally Recognized Testing Laboratory (NRTL) by OSHA (The Occupational Safety and Health Administration) in the United States and as a Product Certification Body by SCC (Standards Council of Canada) in Canada. This mark demonstrates compliance with National Electric Code, OSHA, and SCC regulations and requirements.
	Resolution 92/98	-	Argentine Standardization and Certification Institute	Electrical certification mark for Argentinian market.
	ISO 15223-1	5.1.2	Authorized representative in the European Community	<p>Authorized European Representative:                      Emergo Europe B.V.                      Westervoortsedijk 60                      6827 AT Arnhem                      The Netherlands</p> <p>Australian Sponsor:                      Emergo Australia                      Level 20, Tower II                      Darling Park                      201 Sussex Street                      Sydney, NSW 2000                      Australia</p>
	ISO 15223-1	5.1.2	Authorized Swiss Representative	<p>MedEnvoy Switzerland                      Gotthardstrasse 28                      6302 Zug                      Switzerland</p>
	EUMDR 2017/745 ISO 15223-1:2021	Annex VI, Part C	Information to be submitted upon registration of the device and economic operators: The UDI System	Indicates that The Basic UDI-DI is the primary identifier of a device model. It is the device identification assigned at the level of the device unit of use. It is the main key for records in the UDI database and is referenced in relevant certificates and EU declarations of conformity.
	EUMDR 2017/745 ISO 15223-1:2021	Annex I, GSPR 23.2	General Safety and Performance Requirements for Labeling	Indicates that the product is classified as a Medical Device.
	ISO 15223-1	5.3.7	Temperature limit	Indicates the temperature limits to which the medical device can be safely exposed.
	ISO 15223-1	5.3.8	Humidity limitation	Indicates the range of humidity to which the medical device can be safely exposed.

Symbol	Standard	Reference	Title	Description
	ISO 15223-1	5.3.9	Atmospheric pressure limitation	Indicates the range of atmospheric pressure to which the medical device can be safely exposed.
Rx only	FDA 21 CFR Part 801.109	-	Prescription Devices	Indicates the device is to be used under the supervision of a practitioner licensed by law to direct the use of such device. <b>Caution:</b> Federal law restricts this device to sale by or on the order of a Physician, or with the descriptive designation of any other practitioner licensed by the law of the State in which the practitioner practices to use or order the use of the device.
	ISO 15223-1:2021	5.1.8	Importer	Indicates the entity importing the medical device into the locale.
	Singapore Radiation Protection (Non-Ionising Radiation) Regulations	Part VIII Ultrasound Apparatus, Section 29	Caution Ultrasound	Indicates the radiation warning sign required for an ultrasound apparatus in the Singapore market.
	Self Labelling Programme (SLP) of Certified Communications, Multimedia and Hybrid Equipment in Malaysia	-	MCMC Certification Mark	The Certification Mark indicates that the communications, multimedia and hybrid equipment has been certified by appointed Certifying Agency (SIRIM QAS International) as meeting Technical Codes / Technical Specifications / Technical Standards / Technical Checklist / Technical Declaration, Certification Requirements and the Act and Regulations that applies to the Certified Equipment. The Certification Mark is associated with unique ID for the Certificate Holder or Principal, issued by SIRIM QAS International in Malaysia.